

SIX ROBBLEES' INC.

RV Parts & Accessories

2022













Top Brands - Best Prices



Visit our
Customer Website at
sixrobblees.com



TABLE OF CONTENTS

 RV Appliances	<u>6</u>
 Lighting & Electrical	<u>7</u>
 Cleaners & Maintenance	<u>25</u>
 Hardware	<u>32</u>
 Steps & Handrails	<u>38</u>
 RV Covers & Vents	<u>44</u>
 LP Products	<u>50</u>
 Fresh Water	<u>52</u>
 Sewer & Sanitation	<u>56</u>
 Jacks & Levelers	<u>59</u>
 Suspension, Stabilization, Tie-Downs, Slide-Out Repair	<u>60</u>
 Towing	<u>70</u>
 Index	<u>140</u>



ORDERING INFORMATION

Payment Terms

All invoices are due for payment by the 10th of the month, following the month in which the purchase was made. The billing cycle starts on the 26th of the month and continues through the 25th of the next month. If the account should become delinquent and remain unpaid on the 25th of the second month following purchase, a 2% service charge will be applied. Past due accounts may be placed on a cash basis at our option.

Pricing

Prices are consistent with current market conditions and are subject to change without notice.

Shipping

We are happy to ship any product ordered via UPS or common carrier LTL (pallet shipments). Just confirm with your sales representative how you would like your order delivered. In some cases, we may have free local delivery available (commercial addresses only). For a more complete description of our delivery options, please call your local warehouse.

Online Ordering

With an account, you'll be able to: check stock levels and pricing, place an order, check order status, and search account history and A/R balance.

Monthly Specials

We send out monthly flyers to your email with specials that you won't find anywhere else. Sign up for our monthly specials at www.sixrobblees.com.

Returns

No returns will be accepted without a return authorization number. A restocking fee may be levied on returned merchandise.

Disclaimer

Six Robblees' Inc. has made a diligent effort to illustrate and describe products in this catalog accurately; however, illustrations, photos, and descriptions are for the sole purpose of identification and do not express or imply a warranty that the products are merchantable, or fit for a particular purpose, or that the products will necessarily conform to the illustrations, photos or descriptions. Six Robblees' Inc. makes no warranty or affirmation of fact, express or implied. Six Robblees' Inc. is not responsible for inadvertent typographical errors or omissions. No part of this book may be reproduced or utilized in any form or by means, electronic or mechanical, including recording, photocopying or by any information storage and retrieval system without permission in writing by Six Robblees' Inc. The sole intent of this catalog is to aid Six Robblees' Inc. customers in the resale of trailer and light truck parts.

©2018 by Six Robblees' Inc.

SIX ROBBLEES' HISTORY

Six Robblees' Inc. has been open for business since 1913 and this is our story...

The company was originally started as J.A. Robblee & Co. in Tacoma, WA by three brothers; Jim a sheet metal worker, Bill a locksmith and Herb a bicycle repairman. Although repairing bicycle wheels brought in the majority of their business, by the end of the World War I their experience in tuning bike spokes had been transformed to racing car wheels for drivers of the local Indy car circuit. Over the next several years, other brothers joined the company and lent their expertise. By 1920, a second location was added in Seattle.

Founding brother, Jim passed away in 1930 and willed his interest to his six remaining brothers; Bill, Herb, Fred, Ted, Hank and Dick. The company was then renamed Six Robblees' Inc. The locksmithing operation was sold to some nephews in 1948 when Hank and Dick bought out their retiring brothers; Bill, Fred, Herb and Ted. Dick started Six Robblees' Inc. of Oregon in Portland in 1940 and worked there until selling to Hank's son, Dave in 1987. Hank opened a third location in Yakima in 1964.

Dave Robblee started in 1966 and through the National Wheel and Rim Association (NWRA) expanded the business into custom wheels, installer undercarriage auto parts and a complete line of tire shop supplies and equipment. He was active in signing Six Robblees' up as members of buying groups Heavy Duty America (HDA) and Ascot Tire Supply. In addition, he grew the company by adding 12 branches throughout Alaska, Montana, Oregon and Washington. Amongst some of the branch additions were the purchases of Union Rubber Company (Oakland, CA), Motor Wheel and Parts (Seattle, WA) Dee's Truck Parts (Wasilla, AK), Northwest Wheel (Great Falls, MT), Montana Wheel (Missoula, MT), WIM (Kennewick, WA) and True Wheel Inc. (Vancouver, WA).

The purchase of Motor Wheel and Parts of Seattle, WA and Bearing & Rim of Spokane, WA in 1992 thrust the company into the small trailer parts market and added a solid third market segment to the already thriving truck parts and tire shop supplies categories – all three centered around the wheel.

The new millennium opened with the retirement of Dave Robblee and the promotion of longtime sales & general manager, Tom Ogren, as president. He opened 4 branches, two of which were through the purchases of Tech Supply (Eugene, OR) and Gamo Truck Parts (Grants Pass, OR). Tom retired at the end of 2008 and handed the title of president to Andy Robblee (Dave's son). Andy has added 3 branches and expanded the company into Idaho and Wyoming through the purchase of Milo's Auto & Truck (Casper, WY) and Valley Brake & Truck Parts (Twin Falls, ID). In addition, he facilitated the purchase of two Anchorage, AK companies; Custom Truck Inc. and Mobile Trailer Supply.

Six Robblees' Inc. has grown from a small family business with 3 employees to a small family business with 22 branches in 8 states. Our product offering has expanded to include car, truck and trailer wheels as well as small trailer components, light truck accessories, tire shop supplies, equipment and heavy duty parts, and RV parts and supplies. We have seen tremendous growth and improvement in product offering and service; preserving the belief – "Customers deserve great service!" We hope you will join with us as we grow in the future.

Andy Robblee



RV APPLIANCES



Polar®

The Norcold Polar® series of refrigerators offer both DC compressor and gas absorption models for the perfect fit and function.



7 CUBIC FEET



8 CUBIC FEET

SKU	Description	Cutout Dimensions (in.) H x W x D	Power
NA8LX.3R*	8 cu. ft., Cold Weather Kit RH	59 7/8 x 23 1/2 x 24	AC/LP/DC
NA8LXFR*	8 cu. ft., Fan RH	59 7/8 x 23 1/2 x 24	AC/LP
NA8LXFL*	8 cu. ft., Fan LH	59 7/8 x 23 1/2 x 24	AC/LP
NA8LXIMFL*	8 cu. ft., Ice Maker Fan LH	59 7/8 x 23 1/2 x 24	AC/LP
NA8LXIML*	8 cu. ft., Ice Maker LH	59 7/8 x 23 1/2 x 24	AC/LP
NA8LXR*	8 cu. ft., RH	59 7/8 x 23 1/2 x 24	AC/LP
NA8LXL*	8 cu. ft., LH	59 7/8 x 23 1/2 x 24	AC/LP
NA7LX.3FR**	7 cu. ft., Cold Weather Kit Fan RH	52 7/8 x 23 1/2 x 24	AC/LP/DC
NA7LX.3R**	7 cu. ft., Cold Weather Kit RH	52 7/8 x 23 1/2 x 24	AC/LP/DC
NA7LX.3L**	7 cu. ft., Cold Weather Kit LH	52 7/8 x 23 1/2 x 24	AC/LP/DC
NA7LXFR**	7 cu. ft., Fan RH	52 7/8 x 23 1/2 x 24	AC/LP
NA7LXFL**	7 cu. ft., Fan LH	52 7/8 x 23 1/2 x 24	AC/LP
NA7LXR**	7 cu. ft., RH	52 7/8 x 23 1/2 x 24	AC/LP
NA7LXIMFR**	7 cu. ft., Ice Maker Fan RH	52 7/8 x 23 1/2 x 24	AC/LP
NA7LXL**	7 cu. ft., LH	52 7/8 x 23 1/2 x 24	AC/LP

*Door panels sold separately. Dimensions (in.): upper 15 17/32 x 21 19/32; lower 39 5/8 x 21 19/32

** Door panels sold separately. Dimensions (in.): upper 15 17/32 x 21 19/32; lower 32 5/8 x 21 19/32



LIGHTING/ELECTRICAL

LIGHTING/ELECTRICAL

25 YEARS | 1 MILLION PANELS SOLD



UL US on select ISW inverters!

INDUSTRIAL PURE SINE WAVE INVERTERS

Premium mobile power in a sleek, lightweight profile. Bring reliable power on the road with the new Go Power! Industrial Pure Sine Wave Inverter, available in 200-3000 watts. Provide peace of mind when powering electronics with a 2-year warranty.

PURE SINE WAVE INVERTERS	OUTPUT (watts)	SURGE (watts)	OUTLETS
GP-ISW3000-12	3000	6000	Hard wire
GP-ISW2000-12	2000	3500	2 GFCI
GP-ISW1500-12	1500	2650	2 GFCI
GP-ISW1000-12	1000	1750	2 GFCI
GP-ISW700-12	700	1230	2 GFCI
GP-SW400-12	400	450	2 GFCI
GP-SW200-12	200	260	2

HEAVY DUTY MODIFIED SINE WAVE INVERTERS

Economical power solutions for running lights, appliances, and other resistive loads. The Go Power! Modified Sine Wave Inverters are reliable inverters that range from 225 to 5000 watts and come with a 1-year warranty.

MODIFIED SINE WAVE INVERTERS	OUTPUT (watts)	SURGE (watts)	OUTLETS
GP-5000HD	5000	10000	4 (+HW)
GP-3000HD	3000	6000	4 (+HW)
GP-1750HD	1750	3500	3
GP-1000HD	1000	2000	2
GP-800HD	800	1600	2
GP-400HD	400	800	2
GP-225HD	225	450	2

Don't see the Go Power! inverter you had in mind? Contact your dealer for other available products.

IC Series™

CUT INSTALL TIME IN HALF WITH AN INVERTER/CHARGER



BONUS Remote included

A 3-in-1 system combining an inverter, battery charger, and automatic transfer switch to save space and simplify installation. UL listed, the inverter charger is available in 2000 and 3000 watt models, and comes with a 3-year warranty. Kits include remote.

INVERTERCHARGER	WATTS	SURGE	BATTERY CHARGER	TRANSFER SWITCH	WEIGHT
GP-IC-3000-12-PKG	3000	6000	125 amps	2x 50 amps	51.9 lbs
GP-IC-2000-12-PKG	2000	3400	100 amps	2x 50 amps	38.7 lbs

SOLAR READY BATTERIES



GP-LIFEP04-100



GP-LIFEP04-250

- 12V, 92AH @ C100 | 100AH @ C20
- 36 lbs (16.3 kg)
- 12.9 in x 7 in x 9.2 in

SUN CYCLE™ LITHIUM BATTERY

- 12V, 250AH @ C50
- 80 lbs (36.3 kg)
- 20.5 in x 9.5 in x 8.8 in



GP-AGM-224-6V

SUN CYCLE™ AGM SOLAR BATTERIES



GP-AGM-100-12V

- 6V, 224AH @ C20
- 67.3 lbs (30.5 kg)
- 10.24 in x 7.09 in x 9.72 in

- 12V, 110AH @ C100 | 100AH @ C20
- 67.5 lbs (30.6 kg)
- 12.01 in x 6.61 in x 8.15 in



LIGHTING/ELECTRICAL

LIGHTING/ELECTRICAL

25 YEARS | 1 MILLION PANELS SOLD

Go Power!

NEW ECLIPSE MPPT SOLAR SERIES



Charge batteries faster and maximize your solar charging performance with the new ECLIPSE MPPT solar series. Choose from either a rigid 190-watt or 190-watt Solar Flex panel. Kits are expandable up to 3000-watts with stackable controllers*.

Supercharge your solar array to 98% conversion efficiency with MPPT charging. Ideal for series configurations. Bluetooth® enabled remote* allows you to view and change essential battery stats from your handheld device.

FEATURES Bluetooth® RVC Compatible Lithium Compatible

KITS	AMPS	WATTS	CONTROLLER
GP-ECLIPSE-190	9.45	190	30 AMP
GP-ECLIPSE-FLEX-190	9.89		
GP-ECLIPSE-190-E	9.45	Not Required	
GP-ECLIPSE-FLEX-190-E	9.89		

Compatible with WIRED FOR SOLAR® Pre-wired for Solar RVs



MOST POPULAR KIT

OVERLANDER

NEW 100W

Lithium compatible Controller Bluetooth®

The best-selling solar kits on the market! OVERLANDER and RETREAT kits keep batteries healthy and charged while providing freedom to run lights, water pumps, furnaces, and other DC appliances. Power output warranty: 25 years.

NEW: 100W Slim Solar Panel

EXPANSION KITS	AMPS	WATTS	CONTROLLER
OVERLANDER	9.3	190	
RETREAT	5.4	100	
SLIM SOLAR	5.4	100	

EXPANSION KITS

EXPANSION KITS	AMPS	WATTS
OVERLANDER-E	9.3	190
RETREAT-E	5.4	100
SLIM-100E	5.4	100

SOLAR + INVERTER SYSTEMS

SOLAR EXTREME (570 watts)

- 570 watt, 28.35 amp (3x 190W modules)
- Bluetooth® ready 30 amp PWM digital controller
- 3000 watt pure sine wave inverter charger (with built-in 125 amp battery charger and 50 amp transfer switch)
- Inverter install kit and remote

7+ days

Pair with: 4 or more



WITH Bluetooth® CONTROLLERS

SOLAR ELITE (380 watts)

- 380 watt, 18.9 amp (2x 190W modules)
- Bluetooth® ready 30 amp PWM digital controller
- 2000 watt pure sine wave inverter charger (with built-in 100 amp battery charger and 50 amp transfer switch)
- Inverter install kit and remote

4-7 days

Pair with: 4 x

WEEKENDER ISW (190 watts)

- 190 watt, 9.45 amp (1x 190W module)
- Bluetooth® ready 30 amp PWM digital controller
- 1500 watt industrial pure sine wave inverter
- Pre-wired 30 amp transfer switch
- Inverter install kit and remote

1-4 days

Pair with: 2 x

Don't see the Go Power! product you had in mind? Contact your dealer for other available products.



25 YEARS | 1 MILLION PANELS SOLD

MPPT SOLAR CONTROLLERS

NEW



MAXIMUM
POWER POINT
TRACKING
RV-C COMPATIBLE

Lithium
compatible
Controller

30 AMP MPPT RV-C COMPATIBLE SOLAR CONTROLLER GP-MPPT-30-RVC

MPPT solar controllers optimize an RV's solar charging in all sun and tilt conditions. Easy to install on their own and compatible with all RV-C multiplexing systems, these MPPT solar controllers offer superior flexibility for any RV installation. 5-Year Warranty



OPTIONAL BLUETOOTH® REMOTE GP-RVC-R

Conveniently set and view essential charge information remotely with the GP-RVC-R. The LCD screen shows battery charge current and voltage.

Bluetooth®

MORE SOLAR CONTROLLERS



BLUETOOTH® ENABLED MPPT GP-MPPT-PRO-60

Ideal for larger solar installations, this stackable controller optimizes solar charging using the MPPT charging technology.

MPPT ACCESSORIES

- REMOTE (Optional)
- BLUETOOTH® DONGLE (Optional)



GP-PWM-30-UL

Lithium
compatible
Controller



GP-PWM-10-FM

NEW

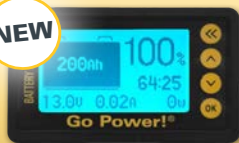

GP-BMK-25

BATTERY MONITOR

View your battery's performance with the Go Power! Battery Monitor Kit (GP-BMK-25). Fit for all battery types, the GP-BMK-25 gives you easy to understand battery stats at the push of a button.

Go Power!

SOLAR FLEX™



Compatible with
WIRED FOR SOLAR®
Pre-wired for Solar RVs

NOW 110W

82% lighter

Lithium
compatible
Controller

Conforms to the RV rooftop and eliminates any need for custom mounts. SolarFlex™ kits are fully expandable; add an expansion kit as your needs grow. Ships with a digital solar controller and can be mounted with adhesive or screws for a secure install.

SOLAR FLEX	AMPS	WATTS	CONTROLLER
GP-FLEX-500	28	5x 100	40 amp
GP-FLEX-200	11.2	2x 100	30 amp*
GP-FLEX-100	5.6	100	30 amp*
GP-FLEX-55	2.8	50	10 amp*
GP-FLEX-35	1.7	30	10 amp*
GP-FLEX-100E	5.6	100	Not required
GP-FLEX 50E	2.8	50	Not required

Controllers are Lithium Compatible. 30 amp Controllers are Bluetooth Ready. Bluetooth®

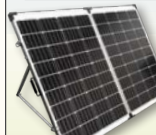

PORTABLE SOLAR KITS

Plug & Play connectivity ensures fast and easy set-up between the panels and the battery. Includes 12' UV cables and a durable carry case.

Compatible with **SOLAR FLEX™** **SIDE** Pre-wired for Solar RVs

KITS	AMPS	WATTS	CONTROLLER
GP-PSK-200	11.2	200	30 amp
GP-PSK-130	6.9	130	10 amp
GP-PSK-90	4.7	90	10 amp

ACCESSORIES	DESCRIPTION
GP-PSK-X30	30' Extension Cable
GP-PSK-7PIN	7 Pin Trailer Adapter

NEW

DURACUBE PORTABLE POWER STATION 500-WATT HOUR SOLAR GENERATOR



Compact, portable power. 500 watt-hour battery pack with a 500-watt pure sine wave inverter.



DURAPACK SOLAR BATTERY PACK 8 WATTS SOLAR + 10,000MAH BATTERY

NEW

Capable of charging cell phones up to 3 times per charge.

DURALITE

Lightweight and easy to use, these portable solar kits are perfect for powering weekend getaways.

NEW



Compatible with **SOLAR FLEX™** **SIDE** Pre-wired for Solar RVs

KITS	AMPS	WATTS	CONTROLLER
GP-DURALITE-100	4.55	100	30 amp
GP-DURALITE-100-E	4.55	100	10 amp



LIGHTING/ELECTRICAL

LIGHTING/ELECTRICAL



RV LED LIGHTING



LPL57CB

LPL57CB **1-LED** license light with built-in bracket



RVILL33



RVILL50



RVILL34



RVILL39



RVILL40

- RVILL33 **9-LED** Single RV interior light; on/off switch
- RVILL34 **18-LED** Double RV interior light; on/off switch
- RVILL39 **9-LED** RV interior light; on/off switch; white snap-on bezel
- RVILL40 **14-LED** Low profile RV interior light; on/off switch
- RVILL50 **24-LED** Oblong RV interior light; 3-way high/low/off switch



RVPL5AB



RVPLL13CB



UCL41CB



ILL70CBBAWN

- RVPL5AB Yellow oval porch light, white housing, no switch
- RVPLL13CB **16-LED** clear oval utility light, black housing, on/off switch
- ILL70CBBAWN **9-LED** 11" awning light, black housing, no switch
- UCL41CB **12-LED** Low profile exterior scene light, 45° downward angle, no switch

RV LED LIGHTING



LIGHTING/ELECTRICAL

LIGHTING/ELECTRICAL

LED LIFETIME WARRANTY
NO BULBS TO REPLACE, EVER!



- MC32ABB** Yellow oblong marker/clearance light, reflex lens, black base
- MC32RBB** Red oblong marker/clearance light, reflex lens, black base
- MCL0032ABB** 1-LED yellow oblong marker/clearance light, reflex lens, black base
- MCL0032RBB** 1-LED red oblong marker/clearance light, reflex lens, black base
- MCL0039ABB** 1-LED 2.5" round yellow marker/clearance light, reflex lens, surface mount
- MCL0039RBB** 1-LED 2.5" round red marker/clearance light, reflex lens, surface mount
- MCL10AKB** 1-LED 3/4" non-directional yellow marker/clearance light kit with grommet
- MCL10RKB** 1-LED 3/4" non-directional red marker/clearance light kit with grommet



- STL73RB** FLEET Count™ 6-LED 6" flange surface mount tail light
- A78RXB** 6" red reflex snap-on trim ring for STL73RB
- STL69RRXB** 11-LED thinline tail light with reflex lens



- RVSTB60** Combination tail light, passenger side, black base
- RVSTB61** Combination tail light, driver side, black base
- RVSTL0060** ONE™ LED Combination tail light, passenger side, white base
- RVSTL0061** ONE™ LED Combination tail light, driver side, white base
- RVSTLB0060** ONE™ LED Combination tail light, passenger side, black base
- RVSTLB0061** ONE™ LED Combination tail light, driver side, black base
- RVSTL10** 6-LED round combination tail light, passenger side
- RVSTL11** 6-LED round combination tail light, driver side
- RVSTL20** 6-LED oblong combination tail light, passenger side
- RVSTL21** 6-LED oblong combination tail light, driver side

RV LED LIGHTING

(800) 275-7499
www.sixrobblees.com

Optronics
BETTER VALUE • BETTER OPTIONS • BETTER LIGHTING



LIGHTING/ELECTRICAL

LIGHTING/ELECTRICAL



Omni Directional Bulb

Specifications: 280 lumens, 3200 kelvin, 2.16 watts, 0.180 amps, Voltage Range: 9-14.5 volts. 60,000 hour bulb life (50 times the life of an 1156 bulb) LED replacement for chandeliers, sconces, taillights, turn signals, back up lights and more. Replaces 67, 93, 105, 199, 1003, 1073, 1093, 1095, 1139, 1141, 1143, 1156, 1159, 1195, 1293, 1295, 1383, 3497, 5007, 5008, 7506, 7527



016-1141-280 Omni-Directional LED Bulb



LED Replacement Bulb

Specifications: 170 lumens, 6500 kelvin, 1.92 watts, 0.16 amps, Voltage Range: 9-15 volts. 60,000 hour life expectancy. Replaces 93, 105, 199, 1003, 1073, 1093, 1095, 1139, 1141, 1143, 1156, 1159, 1195, 1293, 1295, 1383, 3497, 5007, 5008, 7506, 7527.



016-1156-170 Single Contact Bayonet



Wedge LED Bulb

Specifications: 280 Lumens, 3200 kelvin, 2.16 watts, 0.180 amps, Voltage: 9-14.5. 60,000 hour life. Replaces 158, 161, 168, 192, 193, 194, 658, 901, 904, 906, 912, 915, 916, 917, 918, 920, 921, 922, 923, 3652.



016-921-280 921 LED Tower Bulb 280 LMS



JC10 LED Bulb



016-02-JC10 JC-10 Halogen 12-volt RV Interior 1/cd



Fluorescent LED Replacement Tube

Interior LED replacement bulb for a 18" fluorescent fixture. Lasts 12 times longer than the standard fluorescent tube. State of the art Pulse Width Modulator (PWM) guarantees the same light output regardless of voltage fluctuations (11-16-volts). Easy 2 wire installation. FCC approved - will not interfere with radio/analog signals.



016-T818 18" Fluorescent Tube LED bulb



921 Tower LED Bulb



Led Omni Directional Tower Fits Wedge/921 Light Fixtures

016-781921 921 Tower LED Omni Directional Tower Fits Wedge/921 Light Fixtures



LED Replacement Bulbs

Specifications: 25 lumens, 6500 kelvin, 0.24 watts, 0.020 amps, Voltage Range: 9-15 volts. Lasts 150 TIMES LONGER than a standard bulb (60,000 hour life expectancy). Energy Efficient- can run 14 Revolution Bulbs for every 1 standard 1036 bulb. Replaces 211-2, 212-2, 1036, 3423, 3425, 6411, 6413, 6418, 6423, 6429, 6451, 6461, 6475, 6486X.

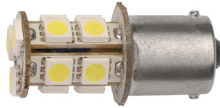

016-194-70 0.24 watts, 0.020 amps, 2 Pk

Bargman LED RV Lights



42-84-410 S/T/T Module (Red) Bulb Socket Plug
42-84-412 Turn Module (Amber) Bulb Socket Plug
42-84-414 Backup Light Module (Red Reflex) Bulb Socket Plug



Round Connectors



In 4-way, 6-way, and 7 way

670-41	4-way Plug, Trailer End
670-42	4-way Socket, Car End
670-61	6-way Plug, No Cableguard
670-61SG	6-way Plug w/ Cableguardd
670-62	6-way Socket, Concealed Terminal
670-71SG	7-way Standard Plug w/ Cable Guard, Trailer End Only
670-72	7-way Split Pin, 2 Hole Mount Socket, Car End Only
670-722	7-way Rubber Boot for Socket



Flat Connectors



A20WB	4-way 20' Wishbone Harness
A25WB	4-way 25' Wishbone Wiring Harness
A35WB	4-way 35' Wishbone Harness
A35WSBP	5-way 35' Wishbone Harness

Pollak

Round Connectors



In 4-way, 6-way, and 7 way

11-403P	4-way Connector Plug, Trailer End w/ Cableguard
11-409P	4-way Chrome Plug, Trailer End
11-410P	4-way Chrome Socket, Car End
11-608P	6-way Connector Socket, W/ Rubber Boot
11-700P	7-way Standard Plug, Trailer End Only
11-902	7-way Weather Beater Plug w/ Cable Guard
11-704P	7-way Nylon Plug, Trailer End Only
11-720P	7-way Solid Pin, 2 Hole Mount Socket, Car End Only
11-723P	7-way Nylon Socket, Car End Only

LIGHTING/ELECTRICAL

LIGHTING/ELECTRICAL



Flat Connectors

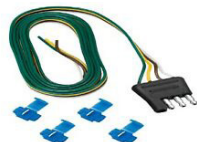

118001	4-way 48" Car End Plug (w/ 4 Wire Taps)
118002	4-way 60" Car End Plug (w/ 4 Wire Taps)
118004	4-way 12" Trailer End Plug
118033	4-way 48" Trailer End Plug
118185	4-way 18" Car/Trailer End Loop (w/ 4 Wire Taps)
118044	4-way 48" Car/Trailer End Loop (w/ 4 Wire Taps)
118045	4-way 60" Car/Trailer End Loop (w/ 4 Wire Taps)
20112	4-Flat Connector Cover
118016	5-way 72" Car End Wiring Harness
118017	5-way 48" Trailer End Wiring Harness
118215	5-way 72" Car & Trailer End Loop



Trailer Plug Adapters



20320	4-Flat Car End Adapter to 6-Way Round Pin
20321	4-Flat Car End Adapter to 7-Way Round Pin, Plastic
20322	4-Flat Car End Adapter to 7-Way Round Pin, Metal
20144	4-Flat to 4-Flat & 7-way Blade
118700	6-Way Round Pin to 4-Flat Adapter
118702	7-Way Flat Pin to 4-Flat Adapter, Display Pack
118709	7-Way Round to 4-Way Flat



15-30 Adapter Plug



- Space saving compact adapter plug
- Molded of durable PVC for long use

A10-1530ARD	Mighty Cord Round Adapter Plug, 15a Male To 30a Female, Bulk
A10-1530ARDVP	Mighty Cord Round Adapter Plug, 15a Male To 30a Female, Carded



15-30 AMP Adapter



Space saving compact adapter plug for use in adapting 15 AMP power for use with 30 AMP trailers. Molded of durable PVC for long use.

- * 15 AMP male x 30 AMP female adapter plug
- * Compact design

A10-1530A	15AM-30AF Adapter Plug, Bulk
A10-1530AVP	15AM-30AF Adapter Plug, Carded



30-15 Adapter



Space saving compact adapter plug for use in adapting 30 AMP power to 15 AMP power. Molded of durable PVC for long use.

A10-3015A	30AM-15AF Adapter Plug, Bulk
A10-3015AVP	30AM-15AF Adapter Plug, Carded



30-50-AMP Adapter



Space saving compact adapter plug for use in adapting 30 AMP power for use with 50 AMP trailers. Molded of durable PVC for long use.

A10-3050A	30AM-50AF Adapter Plug, Bulk
-----------	------------------------------



50-30 AMP Adapter



Space saving compact adapter plug for use in adapting 50 AMP power for use with 30 am trailers. Molded of durable PVC for long use.

A10-5030A	50AM-30AF Adapter Plug, Bulk
A10-5030AVP	50AM-30AF Adapter Plug, Carded



Generator Adapter 30-AMP

Compact adapter plug for connecting 30 AMP generator power to 30 AMP RV power. 30 AMP 3 prong twist lock male connector. Heavy duty molded PVC construction.



A10-G3030A	GEN30AM-RV30AF Adapter Plug, Bulk
A10-G3030AVP	GEN30AM-RV30AF Adapter Plug, Carded

Pollak

7-Way RV Connectors



12-702	Metal Connector Plug, Trailer End Only
12-703	Metal Connector Socket, Car End Only
12-706	Black Plastic Plug, Trailer End Only
12-707	Black Plastic Socket, Car End Only
82-00-3315	7-Way Plug Cover w/ Lanyard

Bargman.

7-Way Molded Connectors



50-67-003	7-way Molded Trailer Cord w/8' cable
50-67-907	7-way Molded Trailer Cord w/4' cable
50-87-007	Straight Truck End (Super Sealed) w/ 7' Cable
50-97-407	Right Angle End w/ 7' Cable



LIGHTING/ELECTRICAL

LIGHTING/ELECTRICAL



15-30 AMP Adapter Cord

This 12" dogbone style cord adapts 15 AMP power for use with 30 AMP RV

- * Heavy duty cable designed for outdoor use
- * 3 Wire, 10 Gauge



A10-1530BK 15AM-30AF, 12", Bulk



15-30-AMP Dogbone Adapter



- * 15 AMP male to 30 AMP female dogbone adapter cord
- * 12" length
- * Heavy duty cable designed for outdoor use
- * 125V

A10-1530 15AM-30AF, 12", Red, Bulk

A10-1530HVP 15AM-30AF, 12", Red, Carded



15-50 Adapter Cord

Dogbone style adapter cords constructed with heavy duty cable, designed for outdoor use.



A10-1550 15AM-50AF, 12", Bulk

A10-1550VP 15AM-50AF Adapter Cord, 12", Red, Carded



30-15 AMP Adapter



This 12" dogbone style cord adapts 30 AMP power for use with 15 AMP RV, and has a finger grip male end for ease of use. Heavy duty cable, designed for outdoor use.

- * 30 AMP male to 15 AMP female dogbone adapter cord
- * 12" length with finger grip male end
- * 3 wire, 10 gauge

A10-3015 30AM-15AF w/Handle, 12", Red, Bulk

A10-3015HVP 30AM-15AF w/Handle, 12", Red, Carded



30-15 AMP Adapter



A10-3015BK 30AM-15AF, 12", Bulk



30-50 AMP Adapter Cord

This 12" dogbone style cord adapts 30 AMP power for use



with 50 AMP RV, and has a finger grip male end for ease of use. Heavy duty cable, designed for outdoor use.

A10-3050F 50AM-30AF w/Handle, 12", Red, Bulk

A10-3050HVP 30AM-50AF w/Handle, 12", Red, Carded



30-50 Adapter

This 12" dogbone style cord adapts 30 AMP power for use with 50 AMP RV. Heavy duty cable, designed for outdoor use.



A10-3050FBK 50AM-30AF, 12", Bulk



50-30 AMP Adapter Cord



This 12" dogbone style cord adapts 50 AMP power for use with 30 AMP RV, and has a finger grip male end for ease of use. 50 AMP male to 30 AMP female dogbone adapter cord. 12" length. Heavy duty cable designed for outdoor use. 3 Wire, 10 Gauge.

A10-5030F 50AM-30AF w/Handle, 12", Red, Bulk

A10-5030HVP 50AM-30AF w/Handle, 12", Red, Carded



50-30 AMP Adapter



This 12" dogbone style cord adapts 50 AMP power for use with 30 AMP RV, and has a finger grip male end for ease of use.

- * 50 AMP male to 30 AMP female dogbone adapter cord
- * 12" length
- * Heavy duty cable designed for outdoor use
- * 3 Wire, 10 Gauge

A10-5030FBK 50AM-30AF, 12", Bulk



30-20 AMP Adapter

Generator Y-Adapter cords, 3' in length, adapt 20 AMP and 30 AMP generators to 15/20 AMP multiple outlets (x2). Twist lock receptacles with 3 and 4 prong ends for secure connection. Designed with heavy duty construction for all types of uses.



A10-G20420Y GEN20AM 4P 20AF Y-Adapter, Bulk



30-20 AMP Adapter

Generator Y-Adapter cords, 3' in length, adapt 20 AMP and 30 AMP generators to 15/20 AMP multiple outlets (x2). Twist lock receptacles with 3 and 4 prong ends for secure connection. Designed with heavy duty construction for all types of uses.



A10-G3020Y GEN30AM 3P 20AF Y-Adapter, Bulk



30-20 AMP Adapter

Generator Y-Adapter cords, 3' in length, adapt 20 AMP and 30 AMP generators to 15/20 AMP multiple outlets (x2). Twist lock receptacles with 3 and 4 prong ends for secure connection. Designed with heavy duty construction for all types of uses.



A10-G30420Y GEN30AM 4P 20AF Y-Adapter, Bulk





30-AMP Generator Adapter Cord



Dogbone style adapters for connecting 30 AMP generator power to 30 AMP RV power. 30 AMP 3 prong and 4 prong twist lock connectors, 1' length. Constructed with heavy duty cable designed for outdoor use.

- A10-G30330** GEN30AM 3P RV30AF Adapter Cord, 12", Bulk
- A10-G30330VP** GEN30AM 3P RV30AF Adapter Cord, 12", Carded
- A10-G30350VP** GEN30AM 3P RV50AF Adapter Cord, 12", Carded



30-50 AMP Adapter



Dogbone style adapters for connecting 30 AMP generator power to 30 AMP RV power. 30 AMP 3 prong and 4 prong twist lock connectors, 1' length. Constructed with heavy duty cable designed for outdoor use.

- A10-G30430** GEN30AM 4P RV30AF Adapter Cord, 12", Bulk
- A10-G30430VP** GEN30AM 4P RV30AF Adapter Cord, 12", Carded
- A10-G30450VP** GEN30AM 4P RV50AF Adapter Cord, 12", Carded



20-AMP Generator Extension Cord

Generator extension cords provide additional cord length for longer hook ups. Twist lock design for secure connection. Heavy duty construction for use with 20 AMP devices. 3 and 4 prong receptacle ends.



- A10-G20253E** GEN20A 3P Extension Cord, 25', Bulk
- A10-G20254E** GEN20A 4P Extension Cord, 25', Bulk



30A Extension Cord With Handle



This 30 AMP extension cord extends power up to 25' from the original source and has a finger grip male end for ease of use.

- * 125V, 3 wire, 10 gauge
- * RED, BOXED
- A10-3010EH** 30A Extension Cord w/Handle, 10'
- A10-3015EH** 30A Extension Cord w/Handle, 15'
- A10-3025EH** 30A Extension Cord w/Handle, 25'
- A10-3050EH** 30A Extension Cord w/Handle, 50'



30-AMP Extension Cord

This 30 AMP RV extension cord is available in 25' and 50' lengths to connect RV at campground or home. Constructed with heavy duty 10/3 cable for safe outdoor use - cETL listed.



- A10-3025E** 30A Extension Cord, 25', Bulk
- A10-3050E** 30A Extension Cord, 50', Bulk



30-AMP LED Extension Cord

This 30 AMP RV extension cord with easy grip handles has clear molded ends that light up when powered. Available in 25' and 50' lengths to connect RV at campground or home. Constructed with heavy duty 10/3 cable for safe outdoor use - cUL listed.



- A10-3025EHLED** 30A Extension Cord w/Handle & LED, 25', Bulk
- A10-3050EHLED** 30A Extension Cord w/Handle & LED, 50', Bulk



30-AMP Power Cord



30 AMP heavy duty RV non-detachable power cord with molded male end and loose wires, constructed for safe outdoor use - cETL listed. Finger grip male plug for ease of use.

- A10-3025END** 30A Power Cord w/Handle, 25', Red, Boxed
- A10-3025ENDBK** 30a Power Cord, 25', Bulk



30-AMP Generator Extension Cord

Generator extension cords provide additional cord length for longer hook ups. Twist lock design for secure connection. Heavy duty construction for use with 30 AMP devices. 3 and 4 prong receptacle ends.



- A10-G30253E** GEN30A 3P Extension Cord, 25', Bulk
- A10-G30254E** GEN30A 4P Extension Cord, 25', Bulk



30-AMP Power Cord Set



30 AMP heavy duty RV detachable power cord with locking ring and molded ends, constructed for safe outdoor use - cETL listed. Finger grip male plug for ease of use.

- A10-3025ED** 30A Detach Power Cord w/Handle, 25', Red, Boxed



30 AMP LED Power Cord

30 AMP heavy duty RV detachable power cord with locking ring and molded ends, constructed for safe outdoor use - cETL listed. Finger grip male plug for ease of use.



- A10-3025ED90** 30A 90° LED Detach Power Cord w/Handle, 25', Red, Boxed



LIGHTING/ELECTRICAL

LIGHTING/ELECTRICAL



Extension Cord 50 AMP



This 50 AMP RV extension cord with finger grip male end is available in 25' and 50' lengths to connect RV at campground or home. Constructed with heavy duty 10/3 cable for safe outdoor use - cETL listed. RED, BOXED

A10-5010EH 50A Extension Cord w/Handle, 10'

A10-5015EH 50A Extension Cord w/Handle, 15'

A10-5025EH 50A Extension Cord w/Handle, 25'

A10-5050EH 50A Extension Cord w/Handle, 50'



50A 90 Deg LED Detach Power Cord



A10-5025ED90 50A 90° LED Detach Power Cord w/Handle, 25', Red, Boxed

Parallel Multi-Conductor Wire

Images to the right

03212	Jacketed, blk/wht (100ft)	12/2 gauge
03213	Jacketed, blk/wht (per ft)	12/2 gauge
03217	Jacketed, blk,red (1000ft)	12/2 gauge
03206	Jacketed, blk/wht (100ft)	14/2 gauge
02902	Bonded, red/blk (per ft)	14/2 gauge
03207	Jacketed, wht/blk (per ft)	14/2 gauge
02905	Bonded, brn/yel/grn (per ft)	14/3 gauge
02906	Bonded, wht/brn/yel/grn (100ft)	14/4 gauge
02908	Bonded, wht/brn/yel/grn (per ft)	14/4 gauge
03202	Jacketed, blk/wht (per ft)	16/2 gauge
02911	Bonded, red/blk (per ft)	16/2 gauge
02914	Bonded, brn/yel/grn (per ft)	16/3 gauge
02917	Bonded, wht/brn/yel/grn (per ft)	16/4 gauge
04903	Jacketed Cable (500ft)	16/6 gauge
04904	Jacketed Cable (100ft)	14/4 gauge
04906	Jacketed Cable (100ft)	14/6 gauge
04908	Jacketed Cable (100ft)	14/7 gauge
04915	Jacketed Cable (100ft)	14/4,10/2,12/1
744A5	Jacketed, Articflex (per ft)	14/4 gauge
764A5	Jacketed, Articflex (per ft)	14/6 gauge
75422A5	Jacketed, Articflex (per ft)	14/5,12/2 gauge
76210A5	Jacketed, Articflex (per ft)	12/6,10/1 gauge



50-AMP LED Extension Cord

This 50 AMP RV extension cord with easy grip handles has clear molded ends that light up when powered. Available in 25' and 50' lengths. Constructed with heavy duty 6/3, 8/1 cable for safe outdoor use - cUL listed.



A10-5025EHLED 50A Extension Cord w/Handle & LED, 25', Bulk

A10-5050EHLED 50A Extension Cord w/Handle & LED, 50', Bulk



50-AMP Power Cord Set



50 AMP heavy duty RV detachable power cord with locking ring and molded ends, constructed for safe outdoor use - cETL listed.

A10-5025ED 50A Detach Power Cord w/Handle, 25', Red, Boxed



50-AMP Power Cord



50 AMP heavy duty RV non-detachable power cord with molded male end and loose wires, constructed for safe outdoor use - cETL listed.

A10-5025END 50A Power Cord w/Handle, 25', Red, Boxed

A10-5025ENDBK 50A Power Cord, 25', Bulk



50A Extension Cord

This 50 AMP extension cord extends power up to 25' from the original source.

* 125V

* 3 wire, 10 gauge

A10-5025E 50A Extension Cord, 25', Bulk

A10-5050E 50A Extension Cord, 50', Bulk



Detachable Power Cord

Heavy duty RV power cord features a detachable female receptacle with locking ring. Heavy duty 10 gauge cable. Water tight connections for safe, outdoor use 125V, 3 conductors, cETL listed



A10-3025EDBK 30A Detach Power Cord, 25', Bulk

A10-5025EDBK 50A Detach Power Cord, 25', Bulk

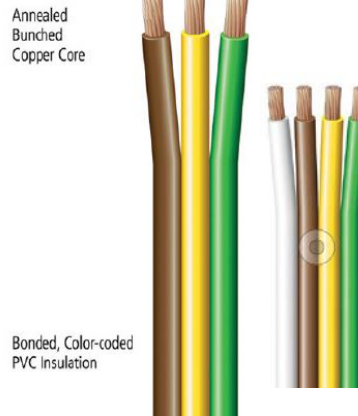



Southwire™

**LIMITED
2 YEAR
WARRANTY**

GASLESS PORTABLE POWER



SOUTHWIRE™ PORTABLE POWER STATIONS

Rechargeable battery-powered electricity to power almost anything you want, wherever you are. All Southwire™ Portable Power stations provide:

- Clean Pure Sine Wave Electricity
- LCD Color Status Display
- DC Input/Output
- 4 Charging Options (200 & 300 Models) – AC Outlet, 12V DC, Generator or Solar Panel
- 5 Charging Options (500 & 1100 Models) AC Outlet, 12V DC, PD, Generator or Solar Panel
- Multiple Output options (AC, DC, USB)
- Built-in LED Flashlight

Ideal for powering and charging your gear – plug in and power up your TV, blender, fan, mini cooler, CPAP, and other devices. Recharge your phone, tablet, laptop, headlamp, and more. Great for emergency and portable power at home. With no gas-powered motor, they're safe indoors!



SOLAR PANEL 100W & MAGNETIC POWER STRIP
(each sold separately)



PART #	DESCRIPTION	WATT-HR	AC OUTLETS	USB PORTS			WEIGHT (LBS)	DIMENSIONS (HxWxD)
				USB-A	USB-C	PD		
53250	Power Station 200	222	2	3	1	27W (Out)	6.6	7.5" x 6.3" x 8.5"
53251	Power Station 300	296	2	3	1	27W (Out)	7.7	7.5" x 6.3" x 8.5"
53252	Power Station 500	515	2	4	1	60W (In/Out) +27W (Out)	11	7.9" x 6.8" x 10.2"
53253	Power Station 1100	1166	3	3	2	100W (In/Out) +27W (Out)	24.6	8.1" x 9.1" x 13.2"
53224	Solar Panel 100W Quad Fold	100W	--	--	--	--	8.4	1.78" x 13.78" x 17.9"
53252K	Power Station 500 Solar Kit (Power Station 500 + 100W Solar Panel)	515	2	4	1	60W (In/Out) +27W (Out)	19.4	7.9" x 6.8" x 10.2" & 1.78" x 13.78" x 17.9"
5127	5-Outlet All-Metal Magnetic 2.4A USB Power Strip with 8' Cord	--	5	2	--	--	3.3	15" x 2" x 5"

1-855-798-6657 | SOUTHWIRE.COM

© 2021 Southwire Company, LLC. All Rights Reserved. ®, ™, and * Trademark of Southwire Company, LLC. Registered in the U.S.





Southwire™

SOUTHWIRE RV TOOL KIT

With Southwire's RV Tool Kit, you will be prepared for any bumps in the road. From loose connections to a dark campsite, our RV Tool Kit has you covered. Southwire's RV Tool Kit is vital to perform basic electrical testing in addition to providing tools for maintenance and quick repairs, allowing you more time to enjoy the great outdoors.



MULTIMETER

Measure Battery & Outlet Voltage, Check Fuses, Test Heating Element.

7-IN-1 MULTI-TOOL PLIER

Perfect for wire cutting, stripping, gripping in addition to crimping new terminals.

MULTI-BIT SCREWDRIVER

Slotted: 3/16", 1/4"
Phillips: #1, #2
Square Recessed: #1, #2
Hex Driver: 1/4", 5/16", 3/8"

LED HEADLAMP

Illuminate work environment hands-free. Adjustable strap.

BUSS BLADE FUSES

10A, 15A, 20A, & 30A rated fuses.

COMPACT POCKET KNIFE

Folding Blade with Liner Lock
Belt Clip

ELECTRICAL TAPE

30 Feet Length

CABLE TIES

14 Inch length

MODEL #	STOCK #	UPC	DESCRIPTION	HEIGHT	WIDTH	LENGTH	WEIGHT
EM-KIT	66983440	0-32886-75081-6	Electrical Maintenance Kit	17"	11"	2.75"	3.7 lbs

**BUILT FOR DURABILITY.
BUILT FOR RELIABILITY.
BUILT FOR WORK.™**

1-855-798-6657 | SOUTHWIRE.COM

©2021 Southwire Company, LLC. All rights reserved.
*Registered Trademark & ™Trademark of Southwire Company, LLC.

LIGHTING/ELECTRICAL

LIGHTING/ELECTRICAL



SURGE GUARD® RV POWER PROTECTION



Check out our new limited lifetime & connected equipment warranties.
Visit rvpower.southwire.com for more information.

FULL ELECTRICAL PROTECTION

Surge Guard full electrical protection products are ideal for larger travel trailers, fifth wheels, and motorhomes that contain more electronics. These products protect the RV by disconnecting the power supply, preventing the bad power from entering the RV. These units provide protection against:

- Power surges
- Open ground
- Open neutral
- Reverse polarity
- Miswired pedestal
- Low and High Voltage

SURGE PROTECTION

Surge Guard surge protection products with pedestal wiring diagnostics are designed for pop-up campers and small travel trailers with less electrical amenities. These devices provide high level surge protection along with visual identification of a wiring issue or power supply fault.

- Elevated Ground Line Current
- Low and High Frequency
- Load Side Open Neutral (34951 Only)



FULL PROTECTION PORTABLE W/ BLUETOOTH



Automatically shuts off power to RV when electrical fault occurs. Low/high voltage & frequency, open ground, open neutral, reverse polarity, elevated ground line current, and Patent Pending Load Side Open Neutral Protection (34951 Only). Includes Bluetooth communication to optional 40301 display. Multiple displays can be connected to a single Surge Guard. 10 second start up delay and 128 second fault restoration delay. Text based display shows all faults along with real time voltage and amp draw.

34931	30A PORT SURGE GUARD WIRELESS
34951	50A PORT SURGE GUARD WIRELESS
40301	SURGE GUARD WIRELESS DISPLAY



FULL PROTECTION PORTABLE

Automatically shuts off power to RV when electrical fault occurs. Low/high voltage & frequency, open ground, open neutral, reverse polarity, elevated ground line current, and Patent Pending Load Side Open Neutral Protection (34950 Only). 10 second start up delay and 128 second fault restoration delay. Text based display shows all faults along with real time voltage and amp draw.

34930	30AMP SURGE GUARD FULL PROTECTION PORTABLE
34950	50AMP SURGE GUARD FULL PROTECTION PORTABLE W/ LCD DISPLAY



FULL PROTECTION HARDWIRE



Automatically shuts off the power when excessive voltage, low (<102V) and high (>132V), or an open ground or neutral is present. Auto reset on power restoration. Caution light indicates surge failure, miswired pedestal, reverse polarity, and elevated ground voltage. 128 second reset delay. Fits neatly inside RVs electrical compartment. Optional Remote Power Monitor LCD Display. (sold separately).

35530	30AMP SURGE GUARD HARDWIRE
35550	50AMP SURGE GUARD HARDWIRE
40300	REMOTE DISPLAY WITH 50' CABLE



PORTABLE SURGE PROTECTORS



Surge protector designed to handle the high power consumption demands of RVers. Analyzes circuits to identify power supply status. Checks for open ground, open neutral, correct polarity, and reversed lines/ground. Features surge protection indicator and thermal sensor to indicate overheating plug/receptacle. Easy-T-Pull™ plug handles. Weather resistant with a rain-proof cover.

44380	30A PORTABLE W/FULL COVER CSA APPRV		44280	120V, 30A
44390	50A PORTABLE W/FULL COVER CSA APPRV		44290	120/240V, 50A



PORTABLE SURGE PROTECTORS



Identifies faulty park power plus offers surge protection. Analyzes circuits to verify pedestal power. Checks for open ground, open neutral, and correct polarity. Illuminated power status indicators. Easy-T-Pull™ plug handles.

44260	30A SURGE PROTECTOR	44270	50A SURGE PROTECTOR
-------	---------------------	-------	---------------------



LIGHTING/ELECTRICAL



BASIC AUTOMATIC TRANSFER SWITCHES

Mechanical interlocking contactors. Time delay at power up. Transfers to generator power automatically when energized after a 30-second delay. 50A, FLA contactor.

40100	BASIC AUTO TRANS SWITCH 50A 120/240V
41300	30A TRANSFER
40140-001	TRANSFER SWITCH 50A 120/240V



REVERSE POLARITY PROTECTION AUTOMATIC TRANSFER SWITCHES

Protects RV from reverse polarity and open ground of shore power. The transfer switch automatically transfers power to the generator when both sources are available, after a 30 second delay.

41301	AUTO TRANS SWITCH 30A
40141-001	TRANSFER SWITCH 50A 120/240V
40101-001	TRANSFER SWITCH 50A 120/240V



SURGE GUARD* AUTOMATIC TRANSFER SWITCH

Protects RV from the most damaging common electrical faults. Transfers to either shore power or generator automatically when energized. In the event both shore and generator powers are available, generator power will dominate after a 30 second delay. Includes 2,600 Joules of surge suppression (fuse protected), and protects against reverse polarity, open ground, open neutral, and low and high voltage.

41261-011	50A SURGE GUARD TRANSFER
-----------	--------------------------



SURGE GUARD* RVC COMPATIBLE AUTOMATIC TRANSFER SWITCH

Same great features as the Surge Guard* ATS plus total electrical protection from faulty park power. Provides added protection from low (<102V) and high (>132V) voltage, miswired pedestal, open ground, and high and low frequency. Oversize contactors 65A, FLA contactor rating. 3,350 Joules of surge protection.

40450RVC	50AMP SURGE GUARD AUTOMATED
40430RVC	30AMP SURGE GUARD AUTOMATED
41390RVC	90A SURGE GUARD TRANSFER
40350RVC	50AMP SURGE GUARD AUTOMATED
40299	REMOTE DISPLAY PANEL
40258	50' COMMUNICATION CABLE



OVER-VOLTAGE ADAPTER

Provides protection for a single 15A receptacle from over-voltage conditions with limited surge protection. Can be used on any 15A receptacle in a RV, home, or campground. Great add-on when using a portable surge protector device to enhance protection.

44300	OVERVOLTAGE ADAPTER 15A
-------	-------------------------



NEUTRAL-GROUND BONDING PLUG

This plug is used on portable generators that are designed with a floating neutral electrical system. All RV full electrical protection devices detect this as an open ground fault and will not allow power to pass through. Simply plug into one of the 15A outlets on the generator to use.

44400	NEUTRAL-GROUND BONDING PLUG
-------	-----------------------------



LOCK HASP

Prevents unauthorized removal of your portable Surge Guard* device from your RV. Also can be used to protect connection points of extension cords and adapters.

*Only compatible with 44260, 44270, 44750.

34590	UNIVERSAL HASP LOCK
-------	---------------------



DIGITAL VOLTAGE MONITOR

Fully tests incoming power for: open ground, reverse polarity, and high/low voltage. Constantly monitors line RMS voltage and checks frequency. Small, rugged construction. Includes audible alarm when electrical fault occurs.

AECM20020	DIGITAL MONITOR
-----------	-----------------

LIGHTING/ELECTRICAL



SURGE GUARD[®] RV POWER PROTECTION



Check out our new limited lifetime & connected equipment warranties.

Visit rvpower.southwire.com for more information.

LIGHTING/ELECTRICAL

SELECT THE LEVEL OF PROTECTION THAT YOUR RV NEEDS	30A Portable 44260	50A Portable 44270	30A Portable 44280	50A Portable 44290	30A Portable 44380	50A Portable 44390	30A Portable 34930	50A Portable 34950	30A Portable 34931	50A Portable 34951	30A Portable 35530	50A Portable 35550
Over/Under Voltage (Input)							•	•	•	•	•	•
Open Neutral Protection (Input)							•	•	•	•	•	•
Open Ground Protection							•	•	•	•	•	•
Overheating Plug/ Receptacle Protection			Indicates	Indicates	Indicates	Indicates	•	•	•	•		
Reverse Polarity Protection (Input)							•	•	•	•	•	•
Surge Failure Indication	•	•	•	•	•	•	•	•	•	•	•	•
Miswired Pedestal Indication	•	•	•	•	•	•	•	•	•	•	•	•
Time Delay at Power Up							10 sec.	10 sec.	10 sec.	10 sec.	128 sec.	128 sec.
Optional Remote LCD Display									40301	40301	40300	40300
Over/Under Frequency Protection							•	•	•	•		
Weather Resistant	•	•	•	•	•	•	•	•	•	•		
UL Listed					•	•					•	•
Source Power Connection Diagnostics	•	•	•	•	•	•	•	•	•	•	•	•
Lock Hasp Available	•	•										
Surge Suppression (Joules)	2,100	4,200	2,100	4,200	2,450	4,200	2,450	4,200	2,450	4,200	2,450	3,850
Max Spike Current (per MOV)	6,500A	6,500A	6,500A	6,500A	6,500A	6,500A	6,500A	6,500A	6,500A	6,500A	6,500A	6,500A



HAND TOOLS, METERS, & LIGHTING



CAMPER'S TOOL KIT

- Multimeter – Measure Battery & Outlet Voltage, Check Fuses
- Multi-Tool Plier – Cut, Grip, Strip Wire, & Crimp
- Multi-Bit Driver – 9 Bits: Phillips, Cabinet, Square, & Hex
- LED Headlamp – 2 Modes: 120 & 50 Lumens. Adjustable Strap
- Pocket Knife – Compact & Folding Blade
- Buss Blade Fuses – 10A, 15A, 20A, & 30A
- Electrical Tape – 30 Feet
- Cable Ties – 14 Inch Length

EM-KIT



MULTIMETER ELECTRICAL TESTER KIT

- Receptacle Tester – Tests standard 120V AC outlets
- Multimeter – 600V AC/DC voltage range
- Non-Contact Voltage Tester – 90-1000V detection range

10037K



MANUAL RANGING MULTIMETER

- 600V AC/DC voltage range
- CAT III 300V safety rating
- Built-in test lead holder
- 7 functions

10031S



400A AC/DC CLAMP METER WITH TRUE RMS

- 400A AC/DC current range
- CAT III 600V safety rating
- True RMS accuracy
- Built-in non-contact voltage tester
- Third-hand test probe holder

21550T



GFCI RECEPTACLE TESTER

- Tests standard 120V AC outlets
- Tests GFCI outlets
- 7 tests in 1

40022S



HEAVY-DUTY 7-IN-1 MULTI TOOL PLIERS

- Heavy-Duty forged steel
- 7-in-1: shears, grips, wire stripper, bolt spanner, bolt shears, crimper, and reamer
- Strips 10-14 AWG SOL and 12-16 AWG STR
- Spring loaded handles

S7N1HD



MULTI TOOL SCREW DRIVERS

- Custom grip handle provides extra comfort & maximum torque
- Durable chrome-plated shaft is rust & corrosion resistant
- Precision-machined quick change bits for driving hex, phillips, slotted, & square head screws

SD12N1 12-IN-1 SCREW DRIVER
SDS6N1 6-IN-1 SCREW DRIVER



EDGEFORCE™ TANTO AND DROP POINT POCKET KNIFE DISPLAY

65088201



EDGEFORCE™ 3.25 DROP POINT D2 KNIFE

- Premium D2 stainless steel stays sharper longer
- Drop point blade for everyday carry
- Stonewash black oxide coated blade for corrosion resistance
- Liner lock keeps blade secure
- Reversible belt clip
- Dual thumb studs for right or left hand opening

DPKD2



EDGEFORCE™ TANTO BLADE D2 KNIFE

- Ideal for piercing, slicing, and tear cuts
- Fine and serrated edge for cutting and tearing
- Stonewash black oxide coated blade for corrosion resistance
- Liner lock keeps blade secure
- Dual thumb studs for right or left hand opening

TBKND2-CAMO



250 LUMEN RECHARGEABLE LED HEAD LAMP

- Five light modes
- Motion sensing mode
- Hard hat clip
- 8 hours long lasting battery life

HL25RSW



120 LUMEN RECHARGEABLE LED HEAD LAMP

- Two light modes
- 120 wide beam angle
- 5 hours long lasting battery life

HL12RSW



2000 LUMEN LED RECHARGEABLE WORK LIGHT

- 2000 to 400 lumens
- Up to 15 hours of runtime
- Rechargeable lithium ion battery with included 120 volt charger

AL20RSW

1-855-798-6657 | SOUTHWIRE.COM
Visit rvpower.southwire.com for more information.

© 2021 Southwire Company, LLC. All Rights Reserved. ®, ™, and * Trademark of Southwire Company, LLC. Registered in the U.S.

PROVIDING
POWER
FOR YOUR
JOURNEY

EASY-T-PULL™ HANDLES

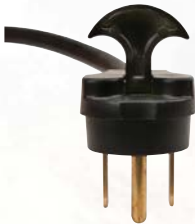

- Convenient easy grip streamline handle
- Easily and safely disconnects from pedestal
- Folds up flush with the plug head
- Integrated into the plug head
- Also available on Surge Guard® products and Shoreline Reels® cord reels



Southwire®

SURGE GUARD® RV POWER PROTECTION



MOLDED ADAPTERS

Easy grip round adapters fit comfortably in any size hand.

15 AMP TO 30 AMP RV ADAPTER

Round
095215508
095213388 Retail Pack

30 AMP TO 15 AMP RV ADAPTER

Round
095225508
095223388 Retail Pack

15 AMP TO 30 AMP RV ADAPTER RIGHT ANGLE

90 degree angled adapter
095245508
095247588 Retail Pack



CORDED ADAPTERS

Heavy duty 15, 30, and 50 Amp adapters. Constructed of 100% copper.

15 AMP MALE TO 30 AMP FEMALE 12" CORD
14/3 cord
15AM30AF12

15 AMP MALE TO 50 AMP FEMALE 18" CORD
10/3 CORD
15AM50AF18

20 AMP MALE TO 50 AMP FEMALE 18" CORD
10/3 CORD
20AM50AF18

30 AMP MALE TO 15 AMP FEMALE 12" CORD
14/3 cord
30AM15AF12

30 AMP MALE TO 50 AMP FEMALE 18" CORD
10/3 cord
30AM50AF18

50 AMP MALE TO 30 AMP FEMALE 18" CORD
10/3 cord
50AM30AF18

RV POWER SUPPLY CORDS



Stripped end makes hardwiring to any connection easy. Male plug end and female plug end are molded. Replaces RV extension cord.

30 AMP MALE 18" POWER SUPPLY CORD
120V, 30A, 10/3 cord
30A18MOST

30 AMP FEMALE 18" POWER SUPPLY CORD
120V, 30A, 10/3 cord
30A18FOST

30 AMP MALE 25" POWER SUPPLY CORD
120V, 30A, 10/3 cord
30A25MOST

30 AMP MALE 30" POWER SUPPLY CORD
120V, 30A, 10/3 cord
30A30MOST

50 AMP MALE 25" POWER SUPPLY CORD
120-240V, 50A, 16/3-8/1 cord
50A25MOST

50 AMP MALE 30" POWER SUPPLY CORD
120-240V, 50A, 16/3-8/1 cord
50A30MOST



RV REPLACEMENT PLUGS

Replaces male plug end of RV extension cords. Repair 30 Amp and 50 Amp extension cords to save cost of replacement. No Easy-T-Pull™ plug handles on these two items.

30 AMP REPLACEMENT PLUG END
Cable range: 12/3 to 10/3
65040201

50 AMP REPLACEMENT PLUG END
Cable range: 10/4 to 4/4
09543 33 08



LIGHTING/ELECTRICAL

LIGHTING/ELECTRICAL



AMP UP! Y-ADAPTER

One 50A, 120/240V female receptacle to two 30A, 120V male plugs. Indicator lights for each 30A plug when power is applied.

44670



RV EXTENSION CORD SETS

Molded plug ends. Constructed of 100% copper.



30 AMP 10' EXTENSION CORD
120V, 30A, 10/3 cord, M&F ends
30A10MFST

30 AMP 25' EXTENSION CORD
120V, 30A, 10/3 cord, M&F ends
30A25MFST

30 AMP 50' EXTENSION CORD
120V, 30A, 10/3 cord, M&F ends
30A50MFST

50 AMP 15' EXTENSION CORD
120-250V, 50A, 6/3-8/1, M&F ends, STW
50A15MFST

50 AMP 30' EXTENSION CORD
120-250V, 50A, 6/3-8/1, M&F ends, STW
50A30MFST



RV FLEX50A™ CORDS

Super flexible 50 amp cords, rating from -50 degrees C to +105 degrees C. Outer jacket is Seoprene Thermoplastic Elastomer (TPE). TPE, along with stranded bare copper conductors, makes FLEX50A the best combination of flexibility and durability on the market.

50 AMP 15' MALE FLEX CORD
6/3-8/1 cord, SEOW, 6" ROJ
50A15MOSE

50 AMP 30' MALE FLEX CORD
6/3-8/1 cord, SEOW, 6" ROJ
50A30MOSE

50 AMP 15' MALE & FEMALE FLEX CORD
6/3-8/1 cord, M&F ends, SEOW
50A15MFSE

50 AMP 30' MALE & FEMALE FLEX CORD
6/3-8/1 cord, M&F ends, SEOW
50A30MFSE

1-855-798-6657 | SOUTHWIRE.COM

Visit rvpower.southwire.com for more information.

© 2021 Southwire Company, LLC. All Rights Reserved. ®, ™, and * Trademark of Southwire Company, LLC. Registered in the U.S.



ZARPAX RV & Marine Dehumidifier



Reusable dehumidifiers for RV & Marine use. Absorbed water does not leak and just needs to be microwaved to recharge.

LV-RM450 Single Pack

LV2-RM450 Double Pack

Sikaflex 221

This fast curing product provides permanent elastic adhesion to a number of surfaces with excellent cut and tear resistance. Designed to resist the shock and abuse of countless road miles, Sikaflex -221 will maintain its strength and adhesion over the long haul. Sikaflex -221 is weather resistant, sandable, paintable and NSF approved for potable water and incidental food contact.



017-106449 Sikaflex 221 Colonial White 300ML Cart

017-90891 Sikaflex 221 White 300ML Cart

017-90892 Sikaflex 221 Alum Gray 300ML Cart

017-90893 Sikaflex 221 Black 300ML Cart

Sikaflex 252

The original elastic bonding adhesive, Sikaflex-252 offers great adhesive strength coupled with elasticity. This combination bonds and seals at the same time, offers gap filling capabilities and compensates for loose tolerances in the building process. Strong enough to reduce or even completely eliminate traditional fastening systems such as welds, rivets, screw and bolts. Excellent Green Strength means less clamping time. Bonds to a wide variety of substrates. Sandable, paintable and NSF approved for incidental food contact.



017-90915 Sikaflex 252 White 10.5 OZ Cart

017-90916 Sikaflex 252 Black 10.5 OZ Cart

Cap Tape

Grey Mylar backed PVC Foam Tape w/adhesive coating. Great for Truck Caps and other areas where a good seal against weather and dust is desired. Also great for quieting rattles and squeaks.



018-1400125B 1/4" X 1 1/2" X 30' - Black

Sikaflex 505

Sikaflex-505 UV is a one-component silane terminated polymer (STP) sealant containing no solvents or isocyanates with excellent UV and weathering resistance. Sikaflex-505 UV offers 60 minute tack free time with adhesion to a wide variety of substrates with little or no surface treatment, has excellent tooling characteristics and non yellowing.



017-415763 STP Sealant

Sikaflex 715

Sikaflex-715, is a cross-linking "chemical curing flexible, elastic, and durable roof sealant". This curing process imparts a highly elastic internal strength not found in traditional RV roof sealant products. It will bond to a variety of roofing component substrates. Unlike other roofing sealants, it has very low VOC's and won't crack under the most extreme conditions! Traditional roof sealants have high shrink characteristics and crack when exposed to the environment.



017-187690 Sikaflex 715 Roof Sealant 300 ML Cart

Weather Stripping

Quality Cap Tape and Weather Stripping products for use around windows, or doors.



018-3161210 3/16" x 1/2" x 10'

018-3163810 3/16" x 3/8" x 10'

018-5163810 5/16" x 3/8" x 10'

Sikasil GP

SikaSil silicone is an acetoxy-curing low modulus sealant used for general seam sealing in interior and exterior applications. It has excellent adhesion to metals, glass, plastics & fiberglass. SikaSil GP has excellent weather stability, is solvent free and is mold & mildew resistant. Elongation of 570%, 300 psi tensile strength, 25 minute tack time and a joint movement accommodation factor of +/-25%, Highly UV resistant.



017-189150 Sikasil Gp Clear Silicone 295 ML Cart

017-189151 Sikasil GP White Silicone 295 ML Cart

Sikasil N-Plus

Sikasil®-N Plus is a general purpose, neutral cure silicone sealant used for interior and exterior applications. Sikasil® N-Plus is highly UV resistant with excellent weather stability and is mold and mildew resistant. Offers excellent sealing joint flexibility for dynamic moving parts. Elongation of 430%, 300 psi tensile strength and 30 minute tack free time.



017-412406 Sikasil N Plus - Clear 295 M

017-412136 Sikasil N Plus - White 295 ML

Sika Multiseal Plus Tape

Sika MultiSeal Plus a new self-adhering, multi-purpose roofing repair tape that, combines an advanced copolymer mastic that exhibits aggressive adhesion with a flexible, non-release, tear proof, UV resistant TPO membrane to create a fast, easy to apply, permanent watertight seal. It can be stretched, cut and folded around intricately shaped roofing accessories to create a to stop water penetration.



017-413828 Sika Multiseal Plus Tape 4" X 50' Roll - White Membrane

Vinyl Foam Tape

Quality Cap Tape and Weather Stripping products for use around windows, doors or anyplace where you are looking to quiet or prevent moisture, dirt and dust from entering.



018-143817 1/4" x 3/8" x 50'

018-381210 3/8" x 1/2" x 50'



CLEANERS & MAINTENANCE

CLEANERS & MAINTENANCE

dicor products
An AIRXCEL Brand

the rv roofing experts



RUBBER ROOF COATING SYSTEMS

Introducing our new color: Tan! Two part, commercial grade systems provides an excellent protective barrier for extending the life of EPDM. Part 2 now available in Standard, CoolCoat™ or Signature. Saves over 25% in labor compared to similar systems. Quick drying time.

A PART 1: CLEANER/ACTIVATOR cleans and prepares EPDM roofing for maximum adhesion of the Part 2 coating. Spray on and rinse off thoroughly. Coverage rate 125 sq. ft. per quart. Biodegradable.

SELECT YOUR COATING OPTION

B PART 2: OPTION 1, ACRYLIC COATING* is an excellent protective barrier extending the life of your rubber roof membrane. Provides superior weatherability and UV resistance. Use with Dicor Rubber Roof Cleaner/Activator for proper adhesion. Requires two coats. Coverage rate of 1 gallon per 125 sq. ft. per coat.

C PART 2: OPTION 2, COOLCOAT™ INSULATING COATING* has Ceramic MicroCells™ to reduce heat transfer, known as heat flux, to the coach interior up to 29%. CoolCoat reflects and dissipates solar heat with tiny yet indestructible vacuum spheres to reduce A/C demand. Use with Dicor Rubber Roof Cleaner/Activator for proper adhesion.

D PART 2: OPTION 3, SIGNATURE EXTENDED LIFE COATING* You may never coat your RV roof again! Our Signature XL is 100% silicone coating. Permanently flexible, unaffected by UV rays and temperature extremes. Signature XL dries to the touch in one hour and is walkable in two. Use with Dicor Rubber Roof Cleaner/Activator for proper adhesion. For EPDM roofs only. Contact Dicor Customer Service for appropriate lap sealants.

A	RP-CRP-Q	1 qt	—
B	RP-CRC-1	1 gal	White
B	RP-CRCT-1	1 gal	Tan
C	RP-IRC-1	1 gal	White
C	RP-IRCT-1	1 gal	Tan
D	RP-SELRC-1	1 gal	White
D	RP-SELRCT-1	1 gal	Tan

*Not for use on metal roofs.



No matter what kind of RV roof you have, we've got you covered!

Rudy



FIBERGLASS ROOF COATING SYSTEM

D PART 1: FIBERGLASS CLEAN AND PREP To ensure proper adhesion of Dicor Fiberglass RV Roof Coating to a fiberglass roof, it is essential to first prepare the surface using Dicor Fiberglass Clean & Prep. Dicor Fiberglass Clean & Prep is specifically formulated to remove all wax, oils, road grit and other contaminants on gel coat and to enhance the adhesion of the roof coating.

Fast Acting Formula • Biodegradable • Easy to use

E PART 2: FIBERGLASS RV ROOF COATING This 100% acrylic resin coating forms a flexible layer over any fiberglass roof to protect and beautify. Dicor Fiberglass RV Roof Coating gives roofs a super bright white finish, which resists mildew and algae and reflects the sun's heat to help keep the interior cooler. Always use Dicor Fiberglass Clean & Prep and allow to dry before applying this coating product. Two coats are required. One gallon of Dicor Fiberglass RV Roof Coating will cover 350 sq. ft. per coat.

Protects roof • Easy to apply • Soap and water clean up

E	RP-FRC-1	1 gal	Fiberglass Clean & Prep	—
F	RP-FCP-1	1 gal	Fiberglass RV Roof Coating	White
F	RP-FRCT-1	1 gal	Fiberglass RV Roof Coating	Tan

RESTORE



METAL ROOF COATING SYSTEM

A METAL ROOF RUST INHIBITIVE PRIMER halts the rusting process and creates a barrier to prevent rust from bleeding through. First remove all surface rust, dirt and debris with a wire brush. Rinse, let dry, then apply the primer which is specifically formulated to reduce further corrosion of metal roofs, while enhancing the adhesion of the DicoR Elastomeric RV Roof Coating. Helps control rust • Water clean up • Easy to use

B COATING READY COVER TAPE For use on metal RV roofing, DicoR Coating Ready Cover Tape is a fleece backed sealing tape for use on metal RV roofing seams prior to coating. Its aggressive grip provides immediate sealing on contact and cures completely in 24 hours. Must be followed with DicoR Elastomeric Coating.

C ELASTOMERIC METAL RV ROOF COATING For use on metal RV roofing (NOT RECOMMENDED FOR EPDM RUBBER, TPO, FIBERGLASS or ALUMINUM ROOFING) DicoR Elastomeric RV Roof Coating protects and beautifies metal, steel, and previously coated RV roofs. DicoR Elastomeric RV Roof Coating is formulated with 100% Acrylic Elastomeric resins to form a rubber-like coating that will expand and contract with the roof movement. Arctic White RV Elastomeric is brilliant white to provide a superior reflectivity, thereby lowering interior temperatures. Requires two coats for adequate protection at an application rate of 1 gallon per 200 sq. ft. per coat.

A	RP-MRRIP-Q	1 qt	Metal Roof Rust Inhibitor Primer
B	RP-CRCT-4-1C	50 ft	Coating Ready Cover Tape
C	RP-MRC-1	1 gal	Elastomeric Roof Coating: White

RV ROOF RENEW KIT

Make your roof look new again! Includes four gallons of DicoR Acrylic Roof Coating, two quarts of DicoR Cleaner/Activator, one 4" x 50' roll Coating Ready Cover Tape, one metal pan, one 9" paint roller, two 9" roller covers, one roll 1" masking tape. Each kit comes with easy-to-follow instructions. Contents will cover a 30 ft. unit. Individual components can be purchased separately.

RP-RRK-30	Roof Renew Kit	White
RP-RRKT-30	Roof Renew Kit	Tan



CLEAN & PROTECT

DicoR's roof care and maintenance products contain no harmful petroleum distillates, harsh abrasives or citric ingredients that can cause irreparable damage.

D E F RV ROOF CLEANER

Formulated specifically for RV Roofs, this biodegradable deep cleaning formula lifts dirt and grime, yet is gentle on the surface. Simply spray on, brush with a medium bristle brush and rinse off. For best results follow with DicoR Roof Gard RV Roof Protectant.



D	RP-RC160C	16 oz	Concentrate
E	RP-RC320S	32 oz	Trigger Spray
F	RP-RC-1GL	1 gal	Trigger Spray Refill



G H ROOF-GARD RV ROOF PROTECTANT

Helps prevent RV roof oxidation caused by harsh UV rays. The mild, nonabrasive formula keeps surfaces cleaner longer with no residue or oily build-up. Contains no silicone, waxes, glycerine or petroleum distillates. Simply spread evenly with a damp mop or cloth and let air dry. Will not harm rubber roofing.

G	RP-RG320S	32 oz	Trigger Spray
H	RP-RG-1GL	1 gal	Trigger Spray Refill



CLEANERS & MAINTENANCE

CLEANERS & MAINTENANCE

dicor products
An AIRXCEL Brand
the rv roofing experts

PATCHi™ ROOF REPAIR KIT

Easily repair punctures, tears, and breaks that can occur in RV and manufactured housing roofs. The kit includes a 9" x 10" peel-and-stick EPDM rubber patch and a tube of lap sealant. Quite versatile by design, it can be used to patch EPDM rubber, most TPO plastic, metal and fiberglass roofing.



402PR	White	PATCHIT
-------	-------	---------

EPDM RUBBER ROOF REPAIR MEMBRANE

Repairs punctures, tears and breaks in EPDM rubber, TPO plastic, metal and fiberglass roofing. This easy to use peel-and-stick material is made of self-adhering EPDM rubber and conforms to most shapes and surfaces, yet remains flexible and strong.



533RM-6	6" x 25' Roll
533RM-12	12" x 25' Roll

BUTYL TAPE

Ideal for sealing uniquely shaped joints. Installs quickly, without gaps. Apply along unusual patterns. Because the sealant is on a continuous roll, installer can work fast and be virtually assured there are no skips or runs in the seal. Priced each.



BT-1834-1	Butyl Tape, Single	1/8" x 3/4" x 30' Roll
BT-1834-5	Butyl Tape, Box of 5	1/8" x 3/4" x 30' Roll
BBT3634-1	Butyl Tape, Black	3/16" x 3/4" x 20' Roll

DiSEAL

The perfect choice to repair any rip, tear or open seam on all RV Roofs.



DiSEAL SEALING TAPE

Now in Tan, DiSeal is a flexible weather resistant compound designed for sealing EPDM rubber, TPO, fiberglass, wood, plastic, steel or aluminum. Permanently seals most leaks immediately and fully cures within 24 hours.



522TPO-4125-1C	4" x 12.5' Roll	White
522TPO-425-1C	4" x 25' Roll	White
522TPO-450-1C	4" x 50' Roll	White
522TPO-66-1C	6" x 6" Patch	White
522TPOT-4125-1C	4" x 12.5' Roll	Tan
522TPOT-425-1C	4" x 25' Roll	Tan
522TPOT-450-1C	4" x 50' Roll	Tan
522AF-450-1C	4" x 50' Roll	Foil
522AF-66-1C	6" x 6" Patch	Foil



REPAIR



SEAL-TITE™ WINDOW RESEAL KIT

Seal-Tite Window Reseal Kit stops existing window leaks and provides a long-lasting, watertight seal for new windows with our unique Seal-Tite Foamcore technology, enough to reseal 6 to 8 windows, depending on size. The Foamcore Kit includes: two rolls of foamcore tape, two tubes of Dicor Products Clear Cap Sealant, a Putty knife, a spray bottle and instructions.

WINDOW FOAMCORE KIT

WRK-1	\$XXXXX
-------	---------



EPDM AND DIFLEX II ROOF INSTALLATION KIT

Includes two-gallons of 901BA water-based bonding adhesive, 150' of butyl tape used to seal around all accessories and molding, and six tubes of lap sealant. Easy to follow instructions.

401CK	Installation Kit	White (use with BritTEK™ roofing)
401CK-D	Installation Kit	Dove (Bright White)
401CK-T	Installation Kit	Tan
401CK-G	Installation Kit	Grey
401CK-V	Installation Kit	Ivory

TUFFLEX ROOF INSTALLATION KIT

Includes two-gallons of 935BA water-based bonding adhesive, 150' of butyl tape used to seal around all accessories and molding, six tubes of lap sealant and 3 rolls of 1.5" fleece tape. Easy to follow instructions.

435CK-W	Installation Kit	White
---------	------------------	-------



SEAL-TITE™ CORNER SEAL KIT

Corner Seal Kit includes two rolls of Corner Seal Tape, six tubes of Dicor Products Clear Cap Sealant to serve as a conventional putty and cap sealant, a putty knife to remove excess sealant, and a spray bottle for the cleanup process.

CORNER SEAL KIT

CS-114Kit	1.25" x 50'
CS-112Kit	1.50" x 50'
CS-200Kit	2.00" x 50'

SEAL-TITE™ CORNER SEAL

Seal-Tite Corner Seal Tape has an adhesive side consisting of a thick, pressure-sensitive elastomeric seal that sticks and conforms to any smooth or irregular surface, including S-locks. The fleece side provides more superior caulk-cure adhesion than the typical smooth surface of RV exteriors. Designed to be used with Dicor Products Cap Sealant.



SEAL-TITE™ CORNER SEAL

CS114B-1	1.25" x 50'
CS112B-1	1.50" x 50'
CS200B-1	2.00" x 50'



CLEANERS & MAINTENANCE

dicor products
An AIRXCEL Brand
the rv roofing experts

REPLACE

ROOF SYSTEM BONDING ADHESIVES

Water Based Acrylic Bonding Adhesive is environmentally friendly, provides excellent coverage and is easy to apply. Application rate of 160 sq. ft. per gal. Use on moisture absorbent substrates. NOT for use on metal, fiberglass or membrane-to-membrane applications.



901BA-1	1 gal	EDPM AND TPO ONLY
917BA-5	5 gal	EDPM AND TPO ONLY
935BA-1	1 gal	TUFFLEX ONLY

CAP SEALANT HAPS FREE FOR WINDOW AND DOOR APPLICATIONS

Excellent for sealing the perimeters of windows, entry doors, compartment doors and joints made of bare or repainted materials. UV and water resistant. Fast drying, easy gunning and paintable.



351CSCL-1	Clear
351CST-1	Tan
351CSW-1	White
351CSB-1	Black



“When a need arises, Dicor will do what it takes to serve our customers. We embrace continuous improvement on products to fit industry needs.”

Rudy

LAP SEALANT FOR MOST ROOFING APPLICATIONS

Helps create a watertight seal along a roof's edges, air vents, vent pipes and screw heads. Dicor Products Lap Sealant is a versatile sealant formulated for EPDM roofing but also compatible with most other roofing material, including Dicor DiFlex II™, Tufflex™ PVC and BriTEK™ TPO roofing. It offers excellent adhesion to aluminum, mortar, wood, vinyl, galvanized metal and concrete. Continuously seals and remains flexible. Color matched, our lap sealants are UV stabilized to prevent discoloration and deterioration and will not stain or discolor any material to which it is applied.



SELF-LEVELING FOR HORIZONTAL SURFACES

501LSW-1	White
501LSD-1	Dove (Bright White)
501LST-1	Tan
501LSG-1	Grey
501LSV-1	Ivory
501LSB-1	Black
502LSW-1	White
502LSD-1	Dove (Bright White)

SELF-LEVELING HAPS FREE CONTAINS NO HAZARDOUS AIR POLLUTING SOLVENTS

505LSW-1	White
505LSD-1	Dove (Bright White)
505LST-1	Tan
505LSG-1	Grey
505LSV-1	Ivory

NON-SAG NOT SELF LEVELING

551LSW-1	White
551LSD-1	Dove (Bright White)
551LST-1	Tan
551LSG-1	Grey
551LSV-1	Ivory
551LSB-1	Black

CLEANERS & MAINTENANCE

DICOR PRODUCTS COMPLETE ROOFING HEADQUARTERS

Dicor Roofing Systems assures a watertight roof that is easy to maintain and saves energy through its heat reflecting characteristics. It is highly puncture and tear resistant, has superior tensile strength and withstands damaging UV rays. The membrane resists uneven weathering, fading or chalkiness. All Dicor Roofing Systems use the same three installation components: bonding adhesive, butyl tape and lap sealant. These elements can be purchased separately or as a package in the Dicor Products Roof Installation Component Kit.

DIFLEX II™ TPO ROOFING SYSTEM

Softest TPO available. No fleece. Compatible with all Dicor sealants, tapes and adhesives. Color codes: W = Polar White, D = Dove (Bright White), T = Tan, G = Grey, V = Ivory.

Polar White	Dove (Bright White)	Tan	Grey	Ivory	Size
DFI185W-21	DFI185D-21	DFI185T-21	DFI185G-21	DFI185V-21	8'6" x 21'
DFI185W-25	DFI185D-25	DFI185T-25	DFI185G-25	DFI185V-25	8'6" x 25'
DFI185W-30	DFI185D-30	DFI185T-30	DFI185G-30	DFI185V-30	8'6" x 30'
DFI185W-35	DFI185D-35	DFI185T-35	DFI185G-35	DFI185V-35	8'6" x 35'
DFI185W-40	DFI185D-40	DFI185T-40	DFI185G-40	DFI185V-40	8'6" x 40'
DFI195W-21	DFI195D-21	DFI195T-21	DFI195G-21	DFI195V-21	9'6" x 21'
DFI195W-25	DFI195D-25	DFI195T-25	DFI195G-25	DFI195V-25	9'6" x 25'
DFI195W-30	DFI195D-30	DFI195T-30	DFI195G-30	DFI195V-30	9'6" x 30'
DFI195W-35	DFI195D-35	DFI195T-35	DFI195G-35	DFI195V-35	9'6" x 35'
DFI195W-40	DFI195D-40	DFI195T-40	DFI195G-40	DFI195V-40	9'6" x 40'
DFI195W-45	DFI195D-45	DFI195T-45	DFI195G-45	DFI195V-45	9'6" x 45'



Our Polar White membranes are the only RV roofing systems listed by the Cool Roof Rating Council.



DiFlex II Polar White is the RV industry's first and only roofing membrane with the Energy Star certification.

EPDM RUBBER ROOFING SYSTEM

Now available in four colors: B = White, D = Dove (Bright White), T = Tan, G = Grey.

Brite-Ply (White)	Dove (Bright White)	Tan	Grey	Size
85B40-21	85D40-21	85T40-21	85G40-21	8'6" x 21'
85B40-25	85D40-25	85T40-25	85G40-25	8'6" x 25'
85B40-30	85D40-30	85T40-30	85G40-30	8'6" x 30'
85B40-35	85D40-35	85T40-35	85G40-35	8'6" x 35'
85B40-40	85D40-40	85T40-40	85G40-40	8'6" x 40'
95B40-21	95D40-21	95T40-21	95G40-21	9'6" x 21'
95B40-25	95D40-25	95T40-25	95G40-25	9'6" x 25'
95B40-30	95D40-30	95T40-30	95G40-30	9'6" x 30'
95B40-35	95D40-35	95T40-35	95G40-35	9'6" x 35'
95B40-40	95D40-40	95T40-40	95G40-40	9'6" x 40'
95B40-45	95D40-45	95T40-45	95G40-45	9'6" x 45'

SLIDEOUT ROOFING SYSTEM EPDM

46B40-10	White	4'6" x 10'
46B40-16	White	4'6" x 16'
46D40-10	Dove (Bright White)	4'6" x 10'
46D40-16	Dove (Bright White)	4'6" x 16'
46T40-10	Tan	4'6" x 10'
46T40-16	Tan	4'6" x 16'

SLIDEOUT ROOFING SYSTEM TPO

DFI146W-10	Polar White	4'6" x 10'
DFI146W-16	Polar White	4'6" x 16'
DFI146D-10	Dove (Bright White)	4'6" x 10'
DFI146D-16	Dove (Bright White)	4'6" x 16'
DFI146T-10	Tan	4'6" x 10'
DFI146T-16	Tan	4'6" x 16'
DFI146V-10	Ivory	4'6" x 10'
DFI146V-16	Ivory	4'6" x 16'



DICOR TUFFLEX™ ROOFING SYSTEMS

The only PVC roofing available that meets Dicor Products stringent performance standards. Easy to maintain, they also save energy with heat reflective characteristics. They are highly puncture and tear resistant, have a superior tensile strength and withstand damaging UV rays. Compatible with Dicor Lap Sealant and Butyl Tape.

DICOR TUFFLEX™ ROOFING SYSTEM

Polar White	
TF95W-25	9'6" x 25'
TF95W-30	9'6" x 30'
TF95W-35	9'6" x 35'
TF95W-40	9'6" x 40'
TF95W-45	9'6" x 45'

BRITETEK™ TPO ROOFING SYSTEM

(May not be suitable for all applications; use with 401CK Installation Kit) Color: White

BTF85W-21	8'6" x 21'
BTF85W-25	8'6" x 25'
BTF85W-30	8'6" x 30'
BTF85W-35	8'6" x 35'
BTF95W-25	9'6" x 25'
BTF95W-30	9'6" x 30'
BTF95W-35	9'6" x 35'
BTF95W-40	9'6" x 40'



HARDWARE

HARDWARE



Hatch Key Lock

- 00e00 5/8" Lock
- 00100 1-1/8" Lock



Thumb Compartment Lock

- 00115 5/8" Lock (pictured)
- 00125 7/8" Lock
- 00135 1-1/8" Lock
- 00145 1-3/8" Lock



Keyed Compartment Lock

- 00155 5/8" Lock
- 00165 7/8" Lock
- 00175 1-1/8" Lock
- 00185 1-3/8" Lock



Compartment Door Finger Pull

- 00195 Stainless Steel, Package



Water Heater Door Latch

- 00225 Metal Door Latch, Package



Wall Vent Latch

- 00235 Thin Wall, 2/Pkg
- 00245 Thick Wall, 2/Pkg



Compartment Key Lock

- 00305 5/8" Lock
- 00315 7/8" Lock (pictured)
- 00325 1-1/8" Lock
- 00335 1-3/8" Lock



Baggage Door Catch

- 10224 Bullet, Blk
- 10225 Square, Blk
- 10234 Bullet, Wht
- 10244 Bullet, Grey
- 10245 Square, Steel
- 10254 Bullet, Colonial Wht
- 10355 Square, Wht



Fold Down Camper Latch

- 10825 Latch & Catch, Zinc (pictured)
- 10835 Catch, Zinc
- 10845 Latch & Catch, Wht
- 10855 Catch, White
- 11845 Latch & Catch, Blk
- 11855 Catch, Blk



Hood Latch

- 10865 Chrome
- 10875 Rubber



Compartment Trigger Latch

- 10935 2" Latch, Blk (pictured)
- 10945 3" Latch, Metal
- 11705 Flush Mount, Blk
- 11715 Offset Mount, Metal



Fold-Out Bunk Clamp

- 20775 White
- 20785 Zinc
- 20795 Extended, Zinc



Rubber Bumper Plug

- 208-A 4" w/ tabs
- 329-A 4-1/4" w/ tabs
- 358-A 4" w/out tabs



Rain Gutter Spouts

- 389PW-A Polar White
- 655-FLEX-PW-A Flexible, Extended Wht
- 655-BK-A Rigid, Extended Blk
- 749-PW-A 3" Extended, Wht



Plastic Thumb Lock

- 433BK-A Black
- 433PW-A Polar White



90° Angle Brackets

- 11695 Steel, 4/pkg



Tri-Lug Window Knob

- 20165 9/16" Wht
- 20175 9/16" Black
- 20185 13/16" Wht
- 20195 13/16" Black



Window Crank

- 20205 1" Plastic, Blk
- 20215 1-3/8" Plastic, Blk
- 20225 1-3/4" Plastic, Blk
- 20265 1" Metal
- 20275 1-3/4" Metal
- 20305 Replacement vent Crank, Metal





Window Knob

20335	1" White
20345	1" Black
20355	1/2" White
20365	1/2" Black



Kappet Screws w/ Covers

20415	White, 14/pkg
20425	Beige, 14/pkg (pictured)
20375	Cover Only, White
20385	Cover Only, Black
20395	Cover Only, Brown



Window Latch

20435	Metal
-------	-------



Plastic Rosettes

20455	White (pictured)
20465	Clear



Closet Pole Socket Set

20535	White
-------	-------



Closet Door Bumper

20545	Beige
-------	-------



Sliding Door Hanger Plate

20555	Metal
-------	-------



Sliding Door Hanger

20565	Metal
-------	-------



Wardrobe Door Guide/Hanger

20575	Top Hanger, (pictured)
20585	Bottom Guide



Sliding/Pocket Adjustable Door Guide

20595	White
-------	-------



Deluxe In-Frame Pocket Door Guide

20605	Brown
-------	-------



Universal Door Security Strap

20615	White
-------	-------



Door Bumper

20625	White
-------	-------



Universal Latch

20645	Brass
20655	Silver



Sliding Mirror Latch

20665	Clear
-------	-------



Lock Pin

20705	Silver
-------	--------



Folding Shelf Bracket

20725	White
20735	Brown



Table Leaf Support

20745	10" 2/pkg
20765	12"



Folding Door Latch/Strike

81855	Plastic
-------	---------



Window Latch

81875	Large
-------	-------



Premium Vinyl Insert

10015	25', Blk
10025	25', Wht
10061	50', Blk
10071	50', Wht
10111	100', Blk
10121	100', Wht



Emergency Window Latch

81925	Plastic, 1 set
-------	----------------



Floor Registers



#02-29005



#02-28935

288-86-AB-PW-A	2"x10" Dampered Plastic, Wht
288-86-AB-TN-A	2"x10" Dampered Plastic, Tan
288-86-A-PW-A	2"x10" Undampered Plastic, Wht
288-86-A-TN-A	2"x10" Undampered Plastic, Tan
02-28905	2"x10" Dampered, Wht
02-28915	2"x10" Dampered, Brn
02-28925	2"x10" Undampered, Wht
02-28935	2"x10" Undampered, Brn
02-28945	4"x8" Undampered, Wht
02-28955	4"x8" Undampered, Brn
02-28965	4"x8" Dampered, Wht
02-28975	4"x8" Dampered, Brn
02-28985	4"x10" Undampered, Wht
02-28995	4"x10" Undampered, Brn
02-29005	4"x10" Dampered, Wht (pictured)
02-29015	4"x10" Dampered Brn

Adjustable Ceiling Vent

ACG150DPW-A	1.5" Collar Depth
ACG25DPW-A	.25" Collar Depth



Ceiling Grill

GRILL2D-A	Dampered, Wht
-----------	---------------



Heat Vents

HV4DBK-A	4" Dampered, Blk
HV4DPW-A	4" Dampered, Wht
HV4DTN-A	4" Dampered, Tan



C-Clip Door Holder

10204	3", Wht (pictured)
10374	5-1/2", Polar Wht
10394PW	C-Clip only, Wht
10535	3", Metal
10595	C-Clip only, Metal



Plunger Door Holder

10284	3" Straight Plunger Door Holder (pictured)
10304	3" Angled Plunger Door Holder
10404	Plunger Door Holder Socket





T-Style Door Holder

- 10324 3-1/2", blk (pictured)
- 10414 3-1/2", wht
- 10434 6" Door Holder, blk
- 10444 6" Door Holder, wht
- 10495 4" Metal
- 10515 4" Stainless Steel
- 10525 6" Stainless Steel



90° T-Style Door Holder

- 06-11875 6", Stainless Steel, (pictured)
- 10605 6", Polar Wht
- 10625 6", Blk
- 11785 4", Stainless Steel



45° T-Style Door Holder

- 11755 Zinc
- 11765 Stainless Steel



Spring Loaded Door Holder

- 10335 2" Door Holder



Ultimate Door Holder

- 10465 4"
- 10475 6"



Fleetwood Door Holder

- 10615 4" Stainless Steel



Pivoting Door Holder

- 10645 3-1/2" 180° Pivot



Low Profile Bumper Door Holder

- 10665 Bumper



Door Bumpers

- 10695 Black
- 10705 White



Ramp Bumper

- 10715 Black



Rubber Bumper

- 11745 1", Black



Door Knob/ Latch Set

- 20495 Metal



Privacy Latch

- 20505 Brown (pictured)
- 20515 Gold



Screen Door Latch

- 10765 Right Hand (pictured)
- 10775 Left Hand
- 06-11865 Bi-Directional Latch



Bullet Screen Door Latch

- 10785 Black



Entry Door Window Frame

- 11011 12"x21" Inside, White
- 11021 12"x21" Inside, Black



Screen Door Stop/Handle

- 11135 12" White
- 11145 12" Black
- 11155 12" Opaque



Screen Door Slider

- 11165 12" White
- 11175 12" Black
- 11185 12" Opaque
- 11195 12" Flat, Clear



Philips Style Screen Latch

- 11205 RHBlack (pictured)
- 11215 LH Black



Coleman Screen Door Latch

- 10795 White



Locking Camper Door Latch

- 10805 Silver (pictured)
- 11675 Black
- 11685 White



Locking T-Handle

- 10885 Chrome
- 10985 Black



Locking L-Handle

- 10895 2-3/4" Inside Cam (pictured)
- 10925 2" Cam



Inside Cam

- 10915 Locking L-Handle (pictured)
- 10905 Inside L-Handle



Assist Handle

- 482-A-2-A Polar White
- 482-A-3-A Black



Deluxe Assist Handle

- 48315 White (pictured)
- 48325 Black



Steel Assist Handle

- 9482-000-020 Chrome Plated
- 9482-000-111 Powder Coated, Wht (pictured)



Full Extension End Cap

- 49615 3/4" x 3/4" x 3/8"
- 49625 3/4" x 1-3/8" x 1/2"
- 49635 3/4" x 1-7/8" x 3/8"



Metal Vinyl End Cap

- 1-3/8" x 1-1/4" x 1/4", 4/pkg
- 49655 White
- 49665 Colonial White
- 49675 Aluminum





Cabinet Barrel Catch

- 70195 w/ Nylon Clip (pictured)
- 70205 w/ Metal Clip



Nylon Friction Catch

- 70215 Metal Clip



Double Roller Cabinet Catch

- 70225 w/ Clip, Wht
- 70235 w/ Prong (pictured)



Roller Catch

- 70245 Heavy Duty
- 70255 Regular (pictured)



Magnetic Catch

- 70265 Side Mount, pictured
- 70275 Surface Mount



Bull Dog Catch

- 70305 2/pkg



Shur-Latch

- 70315 2-1/2" diameter



Concealed Positive Catch

- 70325 Brown



Pull-to-Open Cabinet Catch

- 70395 2/pkg



Spring Loaded Cabinet Catch

- 70435 Black



Cabinet Strike

- 70445 Large
- 70465 Small



Push-to-Open Touch Catch

- 70455 White



Cabinet Catch & Strikes

- 70485 Decorated
- 70495 Plain (pictured)
- 70505 Small



Bead Catch

- 70535 2", Brass



Cabinet Door Strut

- 70545 Metal
- 70555 Plastic (pictured)



Self-Closing Flush Mount Hinge

- 70575 Satin Nickel
- 70585 Antique Brass
- 70595 Brass (pictured)



Free Swing Flush Mount Hinge

- 70655 Satin Nickel
- 70605 Antique Brass
- 70615 Brass (pictured)



3-1/2" Non-Mortise Hinge

- 70625 Brass (pictured)
- 70635 Satin Nickel



Spring Support Hinge

- 70705 Metal



Cabinet Catch & Strikes

- 70715 Question Mark
- 70725 Small "C" Shape (pictured)
- 70735 Large "C" Shape



Roller Drawer Guide

- 70785 Brown



Drawer Slides

- 70795 Drawer Slide
- 70985 Drawer Slide Repair Kit
- 70995 Universal Drawer Slide Kit (pictured)



Cabinet Drawer Lock

- 71005 White



Door/Drawer Bumper

- 71015 1/2", 12/pkg



Sew-In Snap Tape

- 81005 72" Type A, C, E



Curtain Carrier

- 81065 Large Sew-In (A)
- 81075 Snap-In (A)
- 81085 Large Sliding Eye (A) (pictured)
- 81155 Wheeled w/ hook (B)
- 81165 Wheeled w/ ring (B)
- 81265 Small Sew-In (C)
- 81275 Elastic Sew-In (C)
- 81305 Small Sliding Eye (C)
- 81455 Snap-In (E)



Brackets

- 81175 Wall (pictured)
- 81185 Ceiling



Curtain Tabs

- 81285 Type C Sew-In (pictured)



Sew-In Slide Tape

- 81355 72" Type C
- 81365 72" Type D (pictured)



Side Curtain Retainer

- 81485 White



Drape Hook

- 81545 Stainless Steel



Snap Installation Kit

- 81565 Heavy Duty





Snap Kit

- 81575 Fabric-to-Fabric
- 81585 Fabric-to-Wall (Pictured)



Turn Button Assembly

- 81595 4/pkg



Mini Blind Wand

- 81605 12" Wand



Mini Blind Hold Down

- 81625 Metal Hole Style
- 81635 Post Style (pictured)
- 81645 Hook Style



Shower Curtain Ring

- 81665 Metal



Shade Hold Down

- 81705 Pleated Shade
- 81735 Day/Night Shade (pictured)



Shower Door Roller

- 81745 Universal, Wht



End Stop

- 81835 Type B



Mini Blind Brackets

- 81915 Clear



Cord Tensioner

- 81945 Plastic (pictured)
- 81955 Plastic, Extended



Ball Stud

- BS-1005 10 mm



End Fittings

- EF-PS30 Gas Spring Fitting w/ Steel Spring
- EF-PS122 .328" Eyelet (pictured)
- EF-PS130 Gas Spring Fitting w/ Snap On cap
- EF-PS300 Clevis Swivel, 6mm



Gas Spring Mounting Bracket

- BR-1015 Angled
- BR-1020 Flat (pictured)
- BR-10336 Flat
- BR-1060 Angled
- BR-12552 Angled
- BR-12553 Angled



Gas Spring



- GSNI-2125-90 EXT 15 / COMP 9.00 / LBS 90
- GSNI-2200-90 EXT 17 / COMP 10.41 / LBS 90
- GSNI-2300-80 EXT 20 / COMP 11.41 / LBS 80
- GSNI-2300-90 EXT 20 / COMP 11.41 / LBS 90
- GSNI-2300-100 EXT 20 / COMP 11.41 / LBS 100
- GSNI-2300-120 EXT 20 / COMP 11.41 / LBS 120
- GSNI-2300-150 EXT 20 / COMP 11.41 / LBS 150
- GSNI-4033-30 EXT 18 / COMP 11.50 / LBS 30
- GSNI-4900-15 EXT 7.50 / COMP 5.25 / LBS 15
- GSNI-4900-40 EXT 7.50 / COMP 5.25 / LBS 40
- GSNI-5000-20 EXT 10 / COMP 6.41 / LBS 20
- GSNI-5000-60 EXT 10 / COMP 6.41 / LBS 60
- GSNI-5100-30 EXT 12 / COMP 7.91 / LBS 30
- GSNI-5100-40 EXT 12 / COMP 7.91 / LBS 40
- GSNI-5150-20 EXT 15 / COMP 8.91 / LBS 20
- GSNI-5150-40 EXT 15 / COMP 8.91 / LBS 40
- GSNI-5150-60 EXT 15 / COMP 8.91 / LBS 60
- GSNI-5200-30 EXT 17 / COMP 7.66 / LBS 30
- GSNI-5200-40 EXT 17 / COMP 9.66 / LBS 40
- GSNI-5200-50 EXT 17 / COMP 9.66 / LBS 50
- GSNI-5200-60 EXT 17 / COMP 9.66 / LBS 60
- GSNI-5300-10 EXT 20 / COMP 11.41 / LBS 10
- GSNI-5300-20 EXT 20 / COMP 11.41 / LBS 20
- GSNI-5300-30 EXT 20 / COMP 11.41 / LBS 30
- GSNI-5300-40 EXT 20 / COMP 11.41 / LBS 40
- GSNI-5300-50 EXT 20 / COMP 11.41 / LBS 50
- GSNI-5300-60 EXT 20 / COMP 11.41 / LBS 60
- GSNI-6624 EXT 14 / COMP 8.03 / LBS 24
- GSNI-6642 EXT 14.5 / COMP 8.91 / LBS 35
- GSNI-6687 EXT 26.32 / COMP 15.82 / LBS 74
- GSNI-7145 EXT 26.32 / COMP 15.82 / LBS 150



L Bracket



Gas Spring 1/2" L Bracket

- 010-079 3/4" Length
- 010-079-2 3/4" Small "L" Gas Spring - Pair



L Bracket Large



- 010-145-2 Gas Spring L Bracket Large 1-1/4"



Ball Stud



- 010-080-2 Ball Stud- 1 Pair



Table Leg Base



Flush mount, sits flat with RV floor.

- 013-1112 Round Flush Mount Pedestal Base - Chrome



Surface Mount Base



- 013-1119 Round Surface Mount Pedestal Base - Chrome (6 holes)



AP Products

Plastic Rivet

Plastic rivets are 1/4 inches x 1 inch. White. Sold in a 25 pack.

013-140 1" Plastic Rivet White - 25 Pk.



AP Products

Privacy Lock

Polished brass with spherical knob, contemporary design. 2-3/8" round drive-in latch.

013-202 Locking Brass Privacy Knob



AP Products

L300 Lock

Exceeds Federal motorhome vehicle safety standards. Replaces the L300. Opening Requirements: 4 5/8" x 4 7/8". Door Thickness: 1 3/8" - 2". Plate size: Outside 5 1/4" x 5 7/8". Inside 5 1/4" x 5 7/16".

013-257 RV Entrance Motor Home Lock



AP Products

Global Slam Baggage Lock

Baggage Door Slam Lock - Black.

013-573 Global Slam Baggage Lock - Black

013-671 Bauer Slam Baggage Lock - Black



AP Products

Bauer Electric Motor Home Lock

Meets DOT specifications for motor home use. No wiring needed - uses 4 AA batteries to operate (not included). Comes with key for overriding forgotten code or dead battery.

013-531 Electric Motor Home Lock



AP Products

Electric Travel Trailer Lock



It is powered by 4 AA batteries. It is retrofit-table in RV entry doors and is easy to install. Completely programmable with a 4 digit PIN number. Keypad lights up for easy use at night. It possesses the intelligence to know the position of the deadbolt and indicates low battery strength.

013-509 Trailer Entrance Lock

013-530 Electric Travel Trailer Lock - Left Hand

AP Products

Global Travel Trailer Lock W/Keys



Entrance Lock with Paddle and Deadbolt. Directly replaces most Entrance Locks on Travel Trailers and 5th Wheels. Black finish.

013-570 Global Travel Trailer Lock W/Keys - Black

013-571 White Global Travel Trailer Entrance Lock Set

013-572 Chrome Global Travel Trailer Entrance Lock Set

AP Products

Bauer Travel Trailer Lock W/Keys

Direct replacement for standard RV entry door locks. Fits in a 2-3/4" x 3-3/4" cut out. Low Profile Inside Egress to prevent interference with screen door. Corrosion Resistant Lock Cylinders based on ASTM B117-09 1000 hour Salt Fog Test. Lightweight, UV Resistant with Double Sided Key.

013-534 RV Entrance Lock, White

013-535 RV Entrance Lock - Chrome



AP Products

4 X 8 Floor Register



Metal floor register for use with ducted AC or furnaces. Measures 4" x 8" or 4" x 10" both are equipped with shut-off, brown in color.

013-626 4" x 8"

AP Products

4 X 10 Floor Register



013-628 4" x 10"

AP Products

2-1/4 X 10 Floor Register



2-1/4" x 10" Floor register w/damper - Brown.

013-641 Floor Register - Brown W/Damper

AP Products

Exit Window Latch



Exit window latch.

013-242 10" Exit Window Latch



STEPS & HANDRAILS

Prest-o-Fit® *Products RVers Rely On!*



STEP RUGS

OUTRIGGER
RV STEP RUGS

UNIVERSAL



Fits Straight AND Curved Steps

Patent #US10398245B2

Outrigger Universal (22"W) · Fits Steps Up To 8"-11" Deep

Outrigger Universal RV Step Rugs

- Micro-ribbed texture provides better traction
- Easy to install, fitting manual and electric steps
- Made of high-quality UV-protected outdoor carpet
- Fits straight and curved steps



NEW	Universal	2-0393	2-0391	2-0395	2-0392	2-0394
	Universal 3-Pack	2-4133	2-4131	2-4135	2-4132	2-4134

TRAILHEAD
RV STEP RUGS

UNIVERSAL



Fits Straight AND Curved Steps

Patent #US10398245B2

Trailhead Universal (22"W) · Fits Steps Up To 8"-11" Deep

Trailhead Universal RV Step Rugs

- Strong bristle fibers easily remove dirt and debris
- Made of heavy-duty UV-protected outdoor turf
- Easy to install, fitting manual and electric steps
- Fits straight and curved steps



NEW	Universal	2-0220	2-0221	2-0222	2-0223
	Universal 3-Pack	2-4140	2-4141	2-4142	2-4143

RUGGIDS
RV STEP RUGS

UNIVERSAL



Fits Straight AND Curved Steps

Patent #US10398245B2

Ruggids Universal (22" W) · Fits Steps Up To 8"-11" Deep

Ruggids Universal RV Step Rugs

- Deep treads trap dirt at the door
- Made of durable UV-protected outdoor carpet
- Easy to install, fitting manual and electric steps
- Fits straight and curved steps

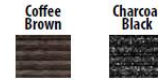

NEW	Universal	2-0431	2-0430
	Universal 3-Pack	2-4126	2-4125

OUTRIGGER
RV STEP RUGS



Designed for straight steps

Outrigger (18" W) · Fits Steps Up To 8" Deep
Outrigger (23" W) · Fits Steps 8"-11" Deep



Designed for curved steps

Outrigger Radius XT (22" W) · Fits Steps 8"-10" Deep

Outrigger RV Step Rugs

- Micro-ribbed texture provides better traction
- Easy to install, fitting manual and electric steps
- Made of high-quality UV-protected outdoor carpet

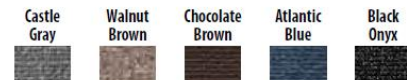

Straight 18"	2-0313	2-0311	2-0315	2-0312	2-0314
	2-0353	2-0351	2-0355	2-0352	2-0354
	2-0383	2-0381	2-0385	2-0382	2-0384
Straight 23"					
Radius XT 22"					

STEPS & HANDRAILS

STEPS & HANDRAILS

Prest-o-Fit® Products RVers Rely On!®



STEP RUGS



NEW TRAILHEAD STEP RUGS

For MORryde® StepAbove® RV STEPS



2 STEP RUG PKG



3 STEP RUG PKG



4 STEP RUG PKG

Trailhead Step Rugs For MORryde® StepAbove® Steps

- Available for 2 Step, 3 Step, and 4 Step in multiple widths
- Made of heavy-duty UV-protected outdoor turf
- Strong bristle fibers easily remove dirt and debris
- Easy to install with included springs and hook & loop fasteners
- Easy to clean, just hose off and dry
- Resistant to fading, mold and mildew

Patent Applied For

MORryde® and StepAbove® are registered trademarks of MORryde International, Inc. Nothing in this advertisement is intended to indicate any affiliation with MORryde International, Inc.

	Step Tread and Rug Width*	Buckskin Brown	Obsidian Black	Fits MORryde® StepAbove® MFG#	
2 STEP RUG PKG	17.5" W	2-0231	2-0230	STP-2-24-09H	
	19.5" W	2-0237	2-0236	STP-2-27-01H	
3 STEP RUG PKG	17.5" W	2-0243	2-0242	STP-3-24-30H	STP-3-24-21H
	19.5" W	2-0249	2-0248	STP-3-27-02H	STP-3-27-05H
	23.5" W	2-0255	2-0254	STP-3-30-03H	STP-3-30-04H
4 STEP RUG PKG	19.5" W	2-0261	2-0260	STP-4-27-05H	
	23.5" W	2-0267	2-0266	STP-4-30-03H	STP-4-32-04H

* FOR FITMENT, MEASURE STEP TREAD WIDTH



Designed for straight steps



Designed for curved steps

Wraparound (18" W) · Fits Steps Up To 8" Deep
 Wraparound+plus (20" W) · Fits Steps 8"-11" Deep · Finished On All Edges
 Jumbo Wraparound+plus (23" W) · Fits Steps 8"-11" Deep · Finished On All Edges
 Wraparound Radius (22" W) · Fits Steps 8"-10" Deep · Finished On All Edges

Wraparound Brand RV Step Rugs

- Protect your interior and accent your exterior
- Made of UV-protected outdoor turf
- Easy to install - fits most manual and electric steps

	Stone Gray	Brown	Green	Imperial Blue	Espresso	Black
Wraparound 18"	2-1043	2-0041	2-0040	2-1041	2-1040	2-1042
Wraparound+Plus 20"	2-1073	2-0071	2-0070	2-1071	2-1070	2-1072
Jumbo Wrap.+Plus 23"	2-1053	2-0051	2-0058	2-1051	2-1050	2-0050
Wraparound Radius 22"	2-0206	2-0201	2-0200	2-0204	2-0203	2-0205



STEPS & HANDRAILS



Surface Mate PATIO RUG

Surface Mate Patio Rug

- UV-protected against sun damage & fading
- Finished on all edges
- Solid marine backing prevents dirt & mud from coming through
- Resistant to mold & mildew

Stake, stick or snap your Surface Mate Patio Rug into place. Four hooked-fiber strips with snap fasteners sewn into the corners give you the freedom to attach the rug to a variety of surfaces. Stake the rug into soft ground using the included metal stakes with washers and highly durable straps, or for a more permanent attachment, drill the four included snap fastener screws into place on a hard wood deck, then simply snap the rug in place. All-weather rugs are made of heavy-duty outdoor turf that features UV-protection plus mold and mildew resistance. Rugs are finished on all edges to prevent fraying and easy to clean.



	Gray	Brown Tan	Green	Imperial Blue	Espresso
6' x 9'	2-1184	2-1181	2-1180	2-1183	2-1182
8' x 12'	2-1204	2-1201	2-1200	2-1203	2-1202

Each Set Contains: 1- Surface Mate Patio Rug, 4 - Rubber Stake-Down Straps, 4 - Ground Stakes with Washers, 8 - Hook-And-Loop Fastening Discs, 4 - Snap Fastener Screw Studs

ATTACHES TO MOST SURFACES!



AERO-WEAVE™ Breathable Outdoor Mat

Aero-Weave Breathable Outdoor Mat

- Allows air and sunlight to flow through
- UV-Protected to prevent sun damage and fading
- Comes in reusable zipper-bag for storage

Better on grass than ordinary patio mats! Made of PVC-coated polyester mesh allowing air and sunlight to flow through. Each mat is UV-protected to prevent sun damage and fading. Includes brass grommets for easy stake-down. Simple to clean with soap and water. Available in 3 colors and comes in a reusable zipper bag for compact and convenient storage.



INCLUDES REUSABLE STORAGE BAG

	Santa Fe Brown	Seascape Blue	Gunmetal Gray
6' x 15'	2-3001	2-3000	2-3003
7.5' x 20'	2-3031	2-3030	2-3033

STEPS & HANDRAILS

STEPS & HANDRAILS

GLOWSTEP REVOLUTION

THE ONLY RV STEP IN THE WORLD WITH **INFINITE** ADJUSTABILITY FOR **INFINITE** RV ACCESSIBILITY

Earth to RV
Eliminates the unsafe diving board effect

For RVs with and without step wells!

Legendary Lifetime Warranty
Made in the USA

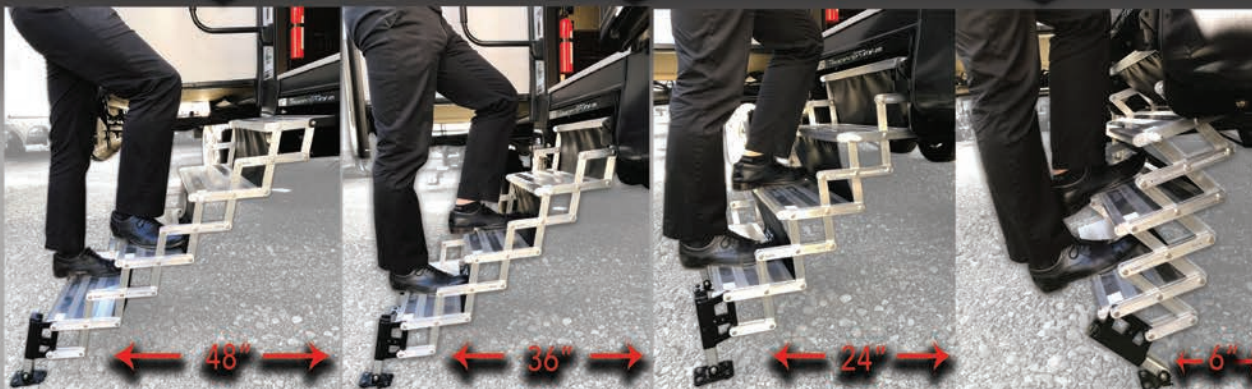

Full deployment at 48"

Ladder deployment at 6"

And everything in between



Patented



New!

- GlowStep Revolution Uprising: Patent pending built-in booster step that increases or reduces the number of steps needed with the flip of a lever
- GlowStep Revolution: Patented design with 7" of vertical precision elevation adjustment, 3 positions of upper adjustment plus an additional 5 positions of lower adjustment
- Easily deploys to accommodate tight spaces or limited proximity with full deployment at 48" to ladder deployment at 6"
- Made from aircraft grade aluminum and stainless steel

GlowStep Revolution Uprising Application Guide
(For RVs with and without a step well)

Max Capacity	Opening between door flanges	Height from bottom of door opening to ground	MFG#	Description
375 lbs	28"	19-7/8" to 27-3/8"	A9003	28" 3-Step Glowstep Revolution Uprising
375 lbs	28"	27-3/8" to 34-7/8"	A9004	28" 4-Step Glowstep Revolution Uprising
325 lbs	28"	34-7/8" to 42-3/8"	A9005	28" 5-Step Glowstep Revolution Uprising
300 lbs	28"	42-3/8" to 49-7/8"	A9006	28" 6-Step GlowStep Revolution Uprising
375 lbs	26"	19-7/8" to 27-3/8"	A9303	26" 3-Step Glowstep Revolution Uprising
375 lbs	26"	27-3/8" to 34-7/8"	A9304	26" 4-Step Glowstep Revolution Uprising
325 lbs	26"	34-7/8" to 42-3/8"	A9305	26" 5-Step Glowstep Revolution Uprising
300 lbs	26"	42-3/8" to 49-7/8"	A9306	26" 6-Step GlowStep Revolution Uprising
375 lbs	24"	19-7/8" to 27-3/8"	A9103	24" 3-Step Glowstep Revolution Uprising
375 lbs	24"	27-3/8" to 34-7/8"	A9104	24" 4-Step Glowstep Revolution Uprising
325 lbs	24"	34-7/8" to 42-3/8"	A9105	24" 5-Step Glowstep Revolution Uprising
300 lbs	24"	42-3/8" to 49-7/8"	A9106	24" 6-Step GlowStep Revolution Uprising

GlowStep Revolution Application Guide
(For RVs with a step well)

MFG#	SIX ROBBLEES#	Description	Width between factory mounting brackets Dimension A (in)	Top of step opening to the ground Dimension B (in)
A8001		27.5" Add-A-Step (For A8002-A8005)	N/A	N/A
A8002		27.5" Two Step GlowStep Revolution	27.5"	18.5" to 24"
A8003		27.5" Three Step GlowStep Revolution	27.5"	25.5" to 32"
A8004		27.5" Four Step GlowStep Revolution	27.5"	32.5" to 40"
A8005		27.5" Five Step GlowStep Revolution	27.5"	39.5" to 48"
A8006		27.5" Six Step GlowStep Revolution	27.5"	46.5" to 56"
A8101		25-25.5" Add-A-Step (For A8102-A8105)	N/A	N/A
A8102		25-25.5" Two Step GlowStep Revolution	25-25.5"	18.5" to 24"
A8103		25-25.5" Three Step GlowStep Revolution	25-25.5"	25.5" to 32"
A8104		25-25.5" Four Step GlowStep Revolution	25-25.5"	32.5" to 40"
A8105		25-25.5" Five Step GlowStep Revolution	25-25.5"	39.5" to 48"
A8106		25-25.5" Six Step GlowStep Revolution	25-25.5"	46.5" to 56"

GlowStep Revolution Accessories

MFG#	SIX ROBBLEES#	Description	
A7621		GlowGuide Handrail	Used for Steps on truck campers, trailers and RV Motorhome Steps
A7602		SafeStep Pet Safety Barrier	Step riser safety panels
A7603		DirtyDestroyer Shoe Cleaner	Shoe cleaning attachment



The latest 2022 part numbers are just a click away!
Visit the online automated application guide available
24/7 at TORKLIFT.COM

For fast and friendly tech support
call us at **1-800-246-8132**



STEPS & HANDRAILS



Aluma Tread Steps



- 358992** Triple Step
- 358991** Quad Step



Pullout Steps



24" Wide, Steel

- 432678** Single Step w/ Tape
- 432682** Double Step w/ Tape
- 432687** Triple Step w/ Tape, 7" Rise
- 432690** Triple Step w/ Tape, 9" Rise
- 432693** Quad Step w/ Tape, 8" Rise



Electric Steps



- 3747453** Single Step, 28 Series, w/ mtr & switch
- 372261** Double Step, 32 Series



Replacement Tread



Makes your step treads visible in low light conditions, measures 6" x 21".

- 909342000** Glow Tread



Motor



Step Motor for all doubles (except 42 series and 47 series) and all singles.

- 379147** Step Motor For All Doubles



25 Series Motor



Designed to help the step automatically retract and extend when coach door is opened and closed.

- 369506** Kwikkee Step Motor for 25 Series



Motor Replacement Kit

Kwikkee 909520000 Motor Replacement Kit For Pre-IMGL/9510 Control Steps Camper Trailer RV



- 379608** Replacement Motor



Replacement Kit

Upgrade your old style Kwikkee step motor and control board with this kit. Fits most 22, 23, 28A, 30, 32, 33, 34, 35, 36, 38 and 40 series steps.



- 379145** Kwikkee Conversion Kit



Control Step

Step Control for steps after 2007 and newer for any single or double step.



- 379146** Step Control W/Override



Magnetic Switch

3/8" diameter core Round Magnetic Door Switch, White, Normally Closed



- 378047** White, 3/8-



Switch Kit Magnet

3/8" Core Round Magnetic Door Switch Black, Normally open.



- 375385** Small Door Jam Switch, Black, 3/8-



Switch Kit Magnet N23

Heavy-Duty Rectangular Magnetic Switch Pack - White (not for use with black control unit)



- 374198** Miniature Rectangular Magnetic Door Switch, White

STEPS & HANDRAILS



Round Switch



Round Electric Step Door Switch is a replacement magnetic switch.

379400 3/4" Round Magnetic Door Switch



Gear & Linkage



Gear & Linkage Kit A Control For Steps Camper Trailer RV.

379160 Gear/Linkage "A" New Style



Linkage Kit



A- style linkage kit used for 22, 23, 30, 32, 33, 34, 35, 36, 38, and 40 step series.

379649 "A" Step Linkage Kit



Linkage Kit



"B"- style Linkage Kit used for 28, 31, 37, and 39 step series.

379648 B- Linkage Kit



Replacement Kit 2



"B"- style IMGL Kit: Improved Motor Linkage Kit used for IMGL (improved motor gear linkage for steps before 2006) 28, 31, 37, and 39 step series, includes control.

379769 "B" Improved Motor Linkage Kit



Control Unit



Engine does not have to be running to activate step. When in the down position, platform is lighted and the anti-skid top provides for maximum safety.

379606 Control Unit For 5323 & 5327 Switches



Pigtail Harness

4-Way plug with packard connector.



369243 4-Way Plug w/ Packard Connector 10" Leads



Cotter & Clevis Pin



The Kwikkee Cotter and Clevis Pin offers a low cost option for replacing worn or broken pins.

379178 Kwikkee Cotter and Clevis Pin



Switch Plunger



This switch is normally open, contacts open when button is out, closed when button is pushed in

379407 Plunger Switch

379388 Switch Plated Plunger



Large Switch



The Kwikkee Large Rectangle Door Switch Kit by Lippert Components is designed to secure the coach door when opened and closed.

379406 Kwikkee Large Rectangle Door Switch Kit



KwikLube



1 Case is 12 11oz. cans

379177 Kwikkee Grease Gun in a Can



RV COVERS & VENTS



Why Choose Classic Accessories RV Covers?

- ✔ Protects against all the elements—rain, sun, wind, snow, hot or cold
- ✔ Longest, hassle-free warranty in the business
- ✔ Perfect fit for any coach, even those extra tall Class A and 5th wheel models
- ✔ Best cover features—most durable and lightweight RV covers make installation a breeze

PermaPRO™ RV Covers

- Extra strength PermaPRO™ ripstop fabric
- Air vent system
- Adjustable front/rear tension panels
- Elasticized hem corners
- Zippered panel RV door access
- Long zipper pulls
- Integrated undercarriage strap system
- Weighted toss bag system
- Tension panels
- Zippered expandable storage bag



PermaPRO™ Fabric

100% WOVEN POLYESTER RIPSTOP

Tear-resistant | Water-repellent | Bird droppings protection | Dirt, dust and scratch protection | UV protection | Snow protection

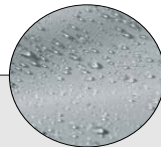

RV COVERS & VENTS

RV PERMAPRO

DESIGNED BY CLASSIC ACCESSORIES



PermaPRO™ Class A RV Cover

MFG #	FITS/DESCRIPTION
80-142-151001-00	MODEL 2: Fits Class A RVs 20'-24' L, 122" Max H
80-328-161001-RT	MODEL 3T: Fits Class A RVs 24'-28' L, 125" Max H
80-329-171001-RT	MODEL 4T: Fits Class A RVs 28'-30' L, 130" Max H
80-330-181001-RT	MODEL 5T: Fits Class A RVs 30'-33' L, 130" Max H
80-331-191001-RT	MODEL 6T: Fits Class A RVs 33'-37' L, 135" Max H
80-184-201001-00	MODEL 7XT: Fits Class A RVs 37'-40' L, 140" Max H
80-333-211001-RT	MODEL 8XT: Fits Class A RVs 40'-42' L, 140" Max H



PermaPRO™ Class B RV Cover

MFG #	FITS/DESCRIPTION
80-411-141001-RT	MODEL 1: Fits Class B RVs up to 20' L, 117" Max H
80-412-151001-RT	MODEL 2: Fits Class B RVs 20'-23' L, 117" Max H
80-413-161001-RT	MODEL 3: Fits Class B RVs 23'-25' L, 117" Max H
80-414-171001-RT	MODEL 4: Fits Class B RVs 25'-27' L, 117" Max H
80-415-161001-RT	MODEL 3T: Fits Class B RVs 23'-25' L, 128" Max H
80-416-171001-RT	MODEL 4T: Fits Class B RVs 25'-27' L, 128" Max H



PermaPRO™ Class C RV Cover

MFG #	FITS/DESCRIPTION
80-127-141001-00	MODEL 1: Fits Class C RVs up to 20' L, 122" Max H
80-128-151001-00	MODEL 2: Fits Class C RVs 20'-23' L, 122" Max H
80-129-161001-00	MODEL 3: Fits Class C RVs 23'-26' L, 122" Max H
80-130-171001-00	MODEL 4: Fits Class C RVs 26'-29' L, 122" Max H
80-131-181001-00	MODEL 5: Fits Class C RVs 29'-32' L, 122" Max H
80-314-191001-RT	MODEL 6T: Fits Class C RVs 32'-35' L, 125" Max H
80-315-201001-RT	MODEL 7T: Fits Class C RVs 35'-38' L, 135" Max H



PermaPRO™ Camper Cover

MFG #	FITS/DESCRIPTION
80-258-141001-00	MODEL 1: Fits Campers 8'-10' L
80-259-151001-00	MODEL 2: Fits Campers 10'-12' L & Lance* 1172 and 1191

*Lance is a brand name of Lance Camper Manufacturing Corporation



PermaPRO™ 5th Wheel and Toy Hauler Cover

MFG #	FITS/DESCRIPTION
80-121-141001-00	MODEL 1: Fits 5th Wheels and Toy Haulers 20'-23' L, 122" Max H
80-122-151001-00	MODEL 2: Fits 5th Wheel and Toy Haulers 23'-26' L, 122" Max H
80-317-161001-RT	MODEL 3T: Fits 5th Wheel and Toy Haulers 26'-29' L, 130" Max H
80-318-171001-RT	MODEL 4T: Fits 5th Wheel and Toy Haulers 29'-33' L, 135" Max H
80-319-181001-RT	MODEL 5T: Fits 5th Wheel and Toy Haulers s 33'-37' L, 135" Max H
80-187-191001-00	MODEL 6XT: Fits 5th Wheel and Toy Haulers 37'-41' L, 140" Max H
80-299-203101-RT	MODEL 7XT: Fits 5th Wheel and Toy Haulers 41'-44' L, 140" Max H



RV COVERS & VENTS

RV PERMAPRO

DESIGNED BY CLASSIC ACCESSORIES



PermaPRO™ Folding Camping Trailer Cover

MFG #	FITS/DESCRIPTION
80-400-301001-RT	MODEL 0: Fits Folding Camper Trailers up to 8'-6" L*
80-401-141001-RT	MODEL 1: Fits Folding Camper Trailers 8'-10" L*
80-402-151001-RT	MODEL 2: Fits Folding Camper Trailers 10'-12" L*
80-403-161001-RT	MODEL 3: Fits Folding Camper Trailers 12'-14" L*
80-404-171001-RT	MODEL 4: Fits Folding Camper Trailers 14'-16" L*
80-405-181001-RT	MODEL 5: Fits Folding Camper Trailers 16'-18" L*
80-406-191001-RT	MODEL 6: Fits Folding Camper Trailers 18'-20" L*

*FIT DIMENSIONS include only the Trailer Body, tow hitch not included



PermaPRO™ R-POD Travel Trailer Cover

MFG #	FITS/DESCRIPTION
80-255-151001-00	MODEL 2: Fits R-POD Travel Trailers up to 16'2" L*
80-256-161001-00	MODEL 3: Fits R-POD Travel Trailers up to 17'7" L*
80-257-171001-00	MODEL 4: Fits R-POD Travel Trailers up to 17'7" L*

*R-POD is a brand name of Forest River Inc.

*FIT DIMENSIONS include only the Trailer Body, tow hitch not included



PermaPRO™ Molded Fiberglass Travel Trailer Cover

MFG #	FITS/DESCRIPTION
80-407-141001-RT	MODEL 1: Fits Molded Fiberglass Travel Trailers 8'-10" L*
80-408-151001-RT	MODEL 2: Fits Molded Fiberglass Travel Trailers 10'11"-13" L*

*FIT DIMENSIONS include only the Trailer Body, tow hitch not included



PermaPRO™ Teardrop Trailer Cover

MFG #	FITS/DESCRIPTION
80-397-141001-RT	MODEL 1: Fits Teardrop Travel Trailers up to 8' L*, 5' W
80-398-151001-RT	MODEL 2: Fits Teardrop Travel Trailers up to 8'-10" L*, 5' W
80-399-161001-RT	MODEL 3: Fits T@B & Clam Shell 10'-12" L*, 6' W

*FIT DIMENSIONS include only the Trailer Body, tow hitch not included

*T@B is a registered trademark of Pleasant Valley Teardrop Trailers



PermaPRO™ Travel Trailer and Toy Hauler Cover

MFG #	FITS/DESCRIPTION
80-321-301001-RT	MODEL 0: Fits Travel Trailers and Toy Haulers 15'-18" L, 114" Max H
80-134-141001-00	MODEL 1: Fits Travel Trailers and Toy Haulers 18'-20" L, 118" Max H
80-135-151001-00	MODEL 2: Fits Travel Trailers and Toy Haulers 20'-22" L, 118" Max H
80-136-161001-00	MODEL 3: Fits Travel Trailers and Toy Haulers 22'-24" L, 118" Max H
80-137-171001-00	MODEL 4: Fits Travel Trailers and Toy Haulers 24'-27" L, 118" Max H
80-138-181001-00	MODEL 5: Fits Travel Trailers and Toy Haulers 27'-30" L, 118" Max H
80-139-191001-00	MODEL 6: Fits Travel Trailers and Toy Haulers 30'-33" L, 118" Max H
80-325-201001-RT	MODEL 7: Fits Travel Trailers and Toy Haulers 33'-35" L, 124" Max H
80-326-211001-RT	MODEL 8: Fits Travel Trailers and Toy Haulers 35'-38" L, 124" Max H
80-327-221001-RT	MODEL 9: Fits Travel Trailers and Toy Haulers 38'-40" L, 124" Max H



Seat Cover



80-112-012401-00 RV Seat Cover Tan - 1 Sz -2cs



RV Wheel Covers



Classic wheel covers sized for a custom fit. Tire sizes are listed on the back of the packages so customers can determine sizing without measuring their tires. Fast and easy slip-on fit, folds up for easy storage. Rugged wipe-clean vinyl with a soft, non-scratch backing, water-repellent and water-resistant. Two wheel covers included in each package.

76230	RV Wheel Covers Sno White 26.75" - 29"
76240	29" To 31-3/4"
76250	32" To 34-1/2"
76260	36" To 39"
76280	40" To 42"



AC Cover



77410	Coleman® Mach I - II - III - Mach 3 Plus - Mach 15 - Roughneck & TSR
80-226-192301-00	Dometic Brisk Air II



Spare Tire Cover



Classic wheel covers sized for a custom fit. Elasticized back hem for a fast and adjustable fit. Rugged wipe-clean vinyl with a soft, non-scratch backing, water-repellent and water-resistant. Tire sizes are listed on the back of the packages so customers can determine sizing without measuring their tires. Comes in three colors; snow white, grey, and black.

75387	30" - 33" - Black
75347	26.75" - 29.75" - Black
80-073-041001-00	30" - 33" - Grey
80-072-021001-00	26.75" - 29.75" - Grey
80-218-042301-00	30" - 33" - White
80-217-022301-00	26.75" - 29.75" - White



Roof Vent Cover

Leave your vent open rain or shine. The Camco Vent Cover offers high-flow ventilation in an aerodynamic design. Removable louvers for easy cleaning. Mounts to existing 14"x14" roof vents. UV stabilized resin for years of rugged use.

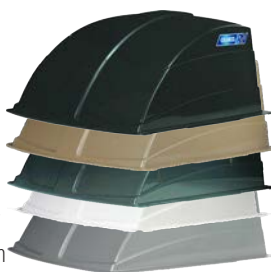

40443	Black
40433	White
40453	Smoke
40463	Champagne
40473	Silver



We Cover Your Gear®



Class B Cover



Fifth Wheel Hitch Cover



Tear Drop Cover



Bike Cover



RV COVERS & VENTS

RV COVERS & VENTS

A FULL LINE OF REPLACEMENT VENT LIDS



Jensen for metal vent (starting with 2004)



Jensen - pin hinge (prior to 1994)



Ventline (prior to 2008)
Elixir (starting with 1994)



Elixir (prior to 1994)



Ventline (starting with 2008)

MATCH YOUR HINGE

Available in white, smoke and black.



CAMCO
www.camco.net

CAMCO

Old Elixir Vent Lid



UV stabilized, fully assembled rust resistant galvanized mounting hardware. Standard 14" x 14"

- 40156** Vent Lid, Elixir pre '94, White
- 40165** Vent Lid, Elixir pre '94, Smoke
- 40170** Vent Lid, Elixir pre '94, Black

CAMCO

Old Jensen Vent Lid



UV stabilized, fully assembled rust resistant galvanized mounting hardware. Two models are available, impact resistant polypropylene and unbreakable polycarbonate. Standard 14" x 14"

- 40154** Vent Lid, Jensen pre '94 pin, White
- 40145** Vent Lid, Jensen pre '94 pin, Smoke
- 40174** Vent Lid, Jensen pre '94 pin, Black

CAMCO

Old Elixir Vent Lid Poly Carb



Unbreakable 14" x 14" vent lids are preassembled and include rust-resistant mounting hardware for quick, easy installation.

- 40162** Vent Lid, Elixir pre '94, White (Polycarb)
- 40172** Vent Lid, Elixir pre '94, Black (Polycarb)

CAMCO

Old Jensen Vent Lid Poly Carb



Unbreakable 14" x 14" vent lids are preassembled and include rust-resistant mounting hardware for quick, easy installation.

- 40160** Vent Lid, Jensen pre '94 pin, White (Polycarb)
- 40175** Vent Lid, Jensen pre '94 pin, Black (Polycarb)

CAMCO

Jensen Vent Lid



UV stabilized, fully assembled rust resistant galvanized mounting hardware. Two models are available, impact resistant polypropylene and unbreakable polycarbonate. Standard 14" x 14"

- 40153** Vent Lid, Jensen Metal Base '94 up, White
- 40173** Vent Lid, Jensen Metal Base '94 up, Black

CAMCO

Ventline Vent Lid



The Camco Vent Lid comes ready for a quick installation right on your RV. UV-stabilized to resist the sun's rays and is rust resistant. Dimensions: 14" W x 14" L. (1) Ventline Lid and Mounting Hardware.

- 40151** Vent Lid, Ventline '08 up, White
- 40176** Vent Lid, Ventline '08 up, Black

CAMCO

Complete Vent Lid Kit



Camco's non-powered roof vents includes a white impact resistant dome, seamless one piece frame, manual crank dome lift, screen, interior garnish ring & galvanized steel roof flanges. Leak proof and weather tight.

40480 Vent Lid, 14"x14"

VALTERRA

Universal Vent Lid



Universal vent lid replaces Jensen, Ventline, Elixir and Ventadome vent lids. Made of durable impact and UV resistant polypropylene

- Rust-resistant mounting hardware included
- 16" x 15" x 3.5"

A10-3375	16" X 15" X 3.5", White, Boxed
A10-3375PB	16" X 15" X 3.5", White, Polybagged
A10-3376	16" X 15" X 3.5", Smoke, Boxed
A10-3376PB	16" X 15" X 3.5", Smoke, Polybagged

CAMCO

Old Ventline Vent Lid



UV stabilized, fully assembled rust resistant galvanized mounting hardware. Standard 14" x 14".

40155	Vent Lid, Ventline pre '08/Elixir '94 up, White
40146	Vent Lid, Ventline pre '08/Elixir '94 up, Smoke
40177	Vent Lid, Ventline pre '08/Elixir '94 up, Black

CAMCO

Vent Insulator



RV Vent Insulator with a full 3" of foam. Reflective surface blocks 100% of the sun's damaging rays.

45192 Vent Insulator, Fits 14" x 14" Vent (W/ Reflective)

CAMCO

Old Ventline Vent Lid Poly Carb



Unbreakable 14" x 14" vent lids are preassembled for quick, easy installation. Replaces models as noted.

40161	Vent Lid, Ventline pre '08/Elixir '94 up, Black (Polycarb)
40178	Vent Lid, Ventline pre '08/Elixir '94 up, Black (Polycarb)

CAMCO

Refrigerator Vent Cover



Fits Dometic, Camco and newer Norcold bases. Made from UV stabilized, durable polypropylene plastic.

42160	Refrigerator Vent Cover -White
421603	Refrigerator Vent Cover -Black

CAMCO

Vent Installation Kit w/ Putty Tape



Comes with screws and grey putty tape

25003 Installation Kit with Putty Tape

CAMCO

Vent Installation Kit w/ Butyl Tape



Comes with screws and butyl tape

25013 Installation Kit with Putty Tape



LP PRODUCTS

LP PRODUCTS

CAMCO

Propane Tank Cover



Fits 20 or 30# Steel Double Tank with an easy access panel for valves. Heavy Duty UV Stabilized Polymer

- 40532 Colonial White (Pictured)
- 40542 White
- 40539 Black

MEC

Single Stage Regulator



Excela-Flow Single Stage Regulator 1/4" FNPT x 3/8" FNPT - 140KBTU/H

- MEGR-230P Single Stage Regulator - Pkg

MEC

Auto Change Regulator

The automatic changeover regulator is your application for two cylinder systems. The changeover feature allows users the benefit of uninterrupted fuel flow to the LP-gas system.



- MEGR-253P Auto Change Regulator, Pkg.

MEC

High Capacity Auto Regulator

LP regulator 2-stage high capacity exce- flow automatic changeover packaged.



- MEGR-253HP Two-Stage High Capacity, Pkg.

MEC

Two Stage Regulator

Compact 2 stage regulator HN excess flow POL inlet x 3/8" FNPT outlet - 90 vent.



- MEGR-295P 2 Stage Regulator, Pkg.
- MEGR-295HP 2 Stage Regulator 9:00 Vent HC

MEC

Two Stage Regulator Bottom Vent

These regulators feature all zinc body construction, high and low 1/8 NPT pressure tap ports, an integral drip lip vent and optional 90 degree vent location. The MEGR-291 series two stage regulator meets RVIA, UL and NFPA test requirements.



- MEGR-291P 291 2-Stage Regulator, Pkg.
- MEGR-291HP Two Stage Regulator - High Capacity, Packaged
- MEGR-291LP Two Stage Regulator - Low Capacity, Packaged

MEC

Two Stage Regulator Side Vent



Combines all the features of the 290 two-stage regular. When mounted horizontally, it's vent is pointed down; under a protective cover. It is approved for use on single vertical cylinders or horizontal tanks. Meets requirements for use on recreational vehicles.

- MEGR-298P 2 Stage Regulator, Pkg.

MEC

High Pressure Regulator



The MEGR-130 is a compact, high pressure, single stage, fixed regulator with 10 to 30 PSI - 1/4" FNPT inlet/outlet. The MEGR-130 can be used to regulate air as well as LP gas.

- MEGR-130-30P 30 PSI - Pkg

MEC

Regulator Cover

Regulator Cover 2 Stage For MEGR-291 298 and 253 Series RV Parts



- MEGR-862P Two Stage Universal Regulator

MEC

Regulator Mounting Bracket



Clear zinc plate, 3.5 inch centerline. MEC Universal L-Mount Regulator Mounting Bracket. L-shaped universal regulator mounting bracket.

- MEGR-900P Z-Mount Universal Regulator Mounting Bracket
- MEGR-RVBP Universal L-Mount Regulator Mounting Bracket

MEC

Type I Pigtail



12" Pigtail Acme Nut X 1/4" I F, Type 1.

- MER425-12P 12' Rv Type 1 Pigtail-Pkg
- MER425-15P 15" ACME x 1/4" Flare, Pkg.
- MER425-24P Thermo Pigtail (1/4" Inverted Flare X QCC, 24" Length)
- MER425-36P 1/4" Inverted Flare with Pigtail Acme Nut
- MER425-48P

MEC

LP Pigtail W/1/4" MPT



15" pigtail. Type 1 ACME x male 1/4" threaded. Connects propane cylinder to regulator. Type 1 ACME end screws to the tank, male 1/4" threads screws into the regulator. Please note that some gas regulators require pigtails with 1/4" inverted flares so doublecheck yours before ordering.

- MER426-15P 15" Pigtail x 1/4" MPT, Pkg.
- MER426-20P 20" Pigtail x 1/4" MPT, Pkg.



Stainless Steel Braided Pigtails



Capacity: Standard QCC - 200,000 BTU/H. Excess Flow Safety Shut-Off. Female QCC, Type I connection x 1/4" inverted male flare. 100% Leak Tested. 350 PSIG Working Pressure.

- MER425SS-15P** 15" Stainless Steel Braided RV Pigtail Hose - 1/4" Male Inverted Flare
- MER425SS-24P** 24" Stainless Steel Braided RV Pigtail Hose - 1/4" Male Inverted Flare
- MER425SS-36P** 36" Stainless Steel Braided RV Pigtail Hose - 1/4" Male Inverted Flare



High Flow Type I Pigtail

400,000 BTU capacity
1/4" ID High pressure thermoplastic hose
1/4" Inv. Flare and 1/4" MPT connection offered



- MER425H-12P** 12" High Flow Type I LP Pigtail - Pkg
- MER425H-15P** 15" Lp Hose High Flow Female
- MER425H-24P** High Flow Thermoplastic Hose, 1/4" Hose ID - 24"



High Flow Stainless Steel Braided Pigtails



For connecting propane cylinders to the propane regulator. Provides added protection to the hose.

- MER425HSS-15P** Stainless Steel Pigtail High Flow - 15"
- MER425HSS-24P** Stainless Steel Pigtail High Flow - 24"



Stay-Longer Hose



Thermoplastic Hose
1-20 female swivel connection, 1-20 male swivel connection, 1-20 male swivel connection

- MER421-144P** 144' Length - Packaged



1/2" Flare Pigtail



48" LP Hose - 3/8" MNPT (Male National Pipe Thread) x 1/2" FFS (Female Flare Swivel) is rated up to 350 PSIG working pressure with a 400 lbs. pull test rating.

- MER611-36P** 36" LP Hose - 3/8" MNPT x 1/2" FFS
- MER611-48P** 48" LP Hose - 3/8" MNPT X 1/2" FFS



3/8" Pigtail



Has two ends and fully crimped brass ferrules. 36" in length with an inside diameter of 3/8". Flexible thermoplastic UL and CGA approved hose. Includes thermal protection.

- MER610-36P** 36" RV Pigtail Hose - 3/8" MNPT X 3/8" FFS
- MER610-48P** 48" RV Pigtail Hose - 3/8" MNPT X 3/8" FFS



3/8" Female Pigtail



Marshall Excelsior MER613 Series Thermalplastic Hose
Thermalplastic hose 3/8 inch Female Flare Swivel x 3/8 inch Female Flare Swivel, 36 inch long

- MER613-36P** 3/8" x 3/8" Female Flare Swivel
- MER613-48P** Hose 36' 3/8 FFS x 3/8 FFS



POL Pigtail

400,000 BTU capacity. Rated up to 350 psi working pressure with a 400 pound pull test rating.
Male soft nose POL, plastic hand wheel and 1-20 male swivel connections.



- MER407-60P** 1/4" Id Hp Hose 60' Pkg



Quick Disconnect Hose Assembly



- MER14TCQD-72P** HP Hose W/Cap
- MER14TCQD-144P** Hp Hose 1/4 Id X 1/4 Mnpt 144"



Adapter, Stay-Longer



Excess flow male hard hose POL 1/4" female inverted flare with check. Female POL 1" 20-Male, packaged.

- ME420P** Stay-Longer Tee



Stay-Longer Adapter



- ME422P** Camping Elbow, QCC1 X Retro-Q X1-20m X 1/4" Inv. Flare, Pkg.



Propane Cylinder Adapter



Excess Flow POL (Prest-O-Lite) x 1"-20 Male with Cap x F. POL x 1-5/16" M. Acme with Quick Closing Poppet - Elbow.

- ME423P** Flow-Longer Elbow Propane Adapter, Pkg.



Bluetooth LP Tank Sensor



Bluetooth Signal Updates Monitor Or Smart Device. Sensor Mounts To Bottom Of Tank. Tank Fuel Level Is Updated Every 5 Seconds. Sensor Communicates To Mobile Device or Monitor In Coach.

- 024-1000** LP Tank Check Dual Sensor w/ Monitor Kit
- 024-1001** LP Tank Check Single Sensor Kit
- 024-1002** LP Tank Check Dual Sensor Kit
- 024-1003** 15 Pack



FRESH WATER

FRESH WATER



Hi-Flow 90° Water Regulator

- Protects RV plumbing against high pressure
- 50-55psi without check valve



A01-02222 Hi-Flow 90° Water Regulator, Brass, Lead-Free, Bulk



Lead-Free Water Regulators

- Protects RV plumbing against high pressure
- Regulates incoming water pressure to 40-50 psi



A01-1120 Water Regulator, Brass, Lead-Free, Bulk

A01-1120VP Water Regulator, Brass, Lead-Free, Carded



Lead-Free High Flow Water Regulators

- Protects RV plumbing against high pressure
- 15% to 20% more flow



A01-1122VP Water Regulator, High Flow, Brass, Lead-Free, Carded



Dust Plug & Strap

- Protects your fresh water system from dust and insects



A0170SVP Water Inlet Plug, 3/4", With Strap, White, Carded



Heated Hose

Heated fresh water supply hose provides drinking water in sub-zero temperatures. The heating source is self-regulating, - no thermostat is required. Heavy duty zippered insulation cuffs at each end are included for added freeze protection. Hose operates at 120VAC/90 Watts.



W01-5315 Heated Water Hose, 1/2" X 15', Blue

W01-5325 Heated Water Hose, 1/2" X 25', Blue

W01-5350 Heated Water Hose, 1/2" X 50', Blue



High Pressure Drinking Water Hose

- High pressure, non-toxic drinking water hose
- Includes easy to use hose gripper
- 160 psi working pressure
- NSF listed materials



W01-5048 Drinking Water Hose, 1/2" x 4', White

W01-5120 Drinking Water Hose, 1/2" x 10', White

W01-5180 Drinking Water Hose, 1/2" x 15', White

W01-5300 Drinking Water Hose, 1/2" x 25', White

W01-5600 Drinking Water Hose, 1/2" x 50', White



Quick Connect Valve Only

The Spray-Port is an auxiliary hook-up without storage. Small and simple, it measures only 4" deep and requires only a 2-3/4" round installation hole. Note: New Coil Hose (not included-sold separately) required to connect to this product. Or a Brass-Quick Connect Adapter (sold separately) is required to attach a garden hose to this product.



PF147005 Quick Connect Valve, 2.75", White (SA-PORT-BTW-RT)



Spray Away Quick Connect Hose

High Quality 15, 3/8" polyurethane coil hose for the Spray Port with Brass insert to fit Spray Port Quick Connector, 15 feet, lightweight, UV resistant hoses, re-coils to just 12 inches.



PF267003 Hose for Spray-Away, 15' Coiled (SA-HOSE-15-ASR)



Hot/Cold Spray Port

High pressure/high volume water follow does a fast, thorough job. Uses a 5-1/2" square installation hole and is only 5-3/4" deep. Note: Coil Hose (not included-sold separately) required to connect to this products.



PF213246 Faucet w/ Quick Connect, 3-3/8", 2 Knob, Plastic, White (P1403M-55QCI)

PF213247 Faucet w/ Quick Connect, 4", 2 Knob, Plastic, White (P1404M-55QCI)



8" Kitchen Faucet



SINGLE LEVER Faucet W/Spray Features reliable washer less cartridges, chrome finishes, all-metal exteriors, brass under bodies, copper supply tubes and 1/2" IPS fittings.

PF211326 Kitchen Faucet, 8", 2 Knob, Plastic-Chrome



8" Kitchen Faucet Lever Handles



Two handle 8" faucet, 8" Down Spout.

PF211327 Kitchen Faucet, 8", 2 Lever Teacup, Plastic, Chrome (P5033A-T44I)

PF221301 Kitchen Faucet, 8", 2 Lever, 1/4 Turn, Plastic, Chrome (R5003-I)



Hi Arc Kitch Faucet



DuraPro underbody, plastic stem and bonnets, chrome lever handles. Phoenix 8 inch Kitchen Faucet. With high-arc spout. DuraPro underbody, plastic stem and bonnets, chrome lever handles.

PF211344 Kitchen Faucet, 8" Hi-Arc, 2 Lever Teacup, Plastic, Chrome (P5034A-T44I)



Hi-Arc Kitchen Faucet

Phoenix U S A High Arc Spout Deck Faucet features 8 inch centers high arc spout sleek contemporary styling.



PF221202 Kitchen Faucet, 8" Hi-Arc, 2 Lever, 1/4 Turn, Plastic, White (R5177-I)

PF221302 Kitchen Faucet, 8" Hi-Arc, 2 Lever, 1/4 Turn, Plastic, Chrome (R5103-I)

PF231302 Kitchen Faucet, 8" Hi-Arc Hybrid, 2 Lever, Chrome (RB5602-I)

PF231321 Kitchen Faucet, 8" Hi-Arc Hybrid, 1 Lever, Ceramic Disc, Chrome (S2102-01-02I)



Pull-Out Kitchen Faucet

A one piece molded underbody formed with plastic resin and powder metal composite. It has sturdy brass encased water connections and is LEAD FREE and EPA certified for up to 45% water savings.



PF231341 Kitchen Faucet, 8" Pull Out Hybrid, 1 Lever, Ceramic Disc, Chrome (SP2104-01-02I)



Hybrid 8" Kitchen Faucet

A one piece molded under body formed with plastic resin and powder metal composite. It has sturdy brass encased water connections and is LEAD FREE and EPA certified for up to 45% water savings.



PF231441 Kitchen Faucet, 8" Pull Out Hybrid, 1 Lever, Ceramic Disc, Brushed Nickel (SP2104-06-02I)



4" Chrome Lavatory Faucet

4" lavatory faucet has clear acrylic handles and comes with chrome or white finish.



PF212307 Lavatory Faucet, 4", 2 Knob, Plastic, Chrome (P4032A-I)



4" Hybrid Lavatory Faucet

A one piece molded underbody formed with plastic resin and powder metal composite makes this a high performance unit. It is LEAD FREE and EPA certified for up to 20% water savings.



PF232301 Bathroom Faucet, 4" Hybrid Low-Arc, 2 Lever, 1/4 Turn, Chrome (RB4602-I)

PF232323 Bathroom Faucet, 4" Single Lever, Tall, Ceramic Disc, Chrome (S1205-I)

PF232401 Bathroom Faucet, 4" Low-Arc Hybrid, 2 Lever, 1/4 Turn, Brushed Nickel (RB4662-I)

PF232421 Bathroom Faucet, 4", Tall, Single Lever, Ceramic Disc, Brushed Nickel (S1265-I)



4" Chrome Lavatory Faucet Teacup

4" Lavatory faucet with a chrome finish. DuraPro underbody with a plastic compression valve.



PF212308 Lavatory Faucet, 4", 2 Lever Teacup, Plastic, Chrome (P4032A-T44I)



4" Bathroom Faucet

Two-handle 4" lavatory faucet with plastic underbody.



PF222201 Bathroom Faucet, 4", 2 Lever, 1/4 Turn, Plastic, White (R4077-I)

PF222301 Bathroom Faucet, 4", 2 Lever, 1/4 Turn, Plastic, Chrome (R4003-I)

PF222501 Bathroom Faucet, 4", 2 Lever Teacup, 1/4 Turn, Plastic, Rubbed Bronze (R4084-I)



4" Bathroom Faucet w/ Diverter Valve

4" decorative Lav-A-Shower faucet with anti-syphon hook up for personal shower.



PF222241 Bathroom Diverter Faucet, 4", 2 Lever, 1/4 Turn, Plastic, White (R4477-I)



Shower Valve W/ Vacuum Breaker

4" decorative shower valve, with vacuum breaker for personal shower.



PF223241 Shower Valve w/ Vac Brkr, 4", 2 Lever, 1/4 Turn, Plastic, White (R0477-I)



2 Lever With D-Spud

4" decorative tub-shower diverted with anti-syphon hook up for personal shower.



PF223261 Tub Div Faucet w/ D-Spud, 4", 2 Lever, 1/4 Turn, Plastic, White (R4777-I)



Shower Valve w/ Breaker

Two handle 4" shower valve. Vacuum breaker for attaching a hand held shower. Plastic underbody.



PF223341 Shower Valve w/ Vac Brkr, 4", 2 Lever, 1/4 Turn, Plastic, Chrome (R0403-I)



FRESH WATER

FRESH WATER



Tub Faucet with D-Spud

Two handle tub filler with diverter and D-Spud for attaching a hand held shower.



PF223361 Tub Div Faucet w/ D-Spud, 4", 2 Lever, 1/4 Turn, Plastic, Chrome (R4703-1)



Shower Valve w/ Breaker

Two handles with a two hole mount. 4" center, with knob handles and a white finish. Under body is plastic and the valves are plastic compression and it has a 2" shank.



PF213244 Shower Valve w/ Vac Brkr, 4", 2 Knob, Plastic, White (P437MV-551)

PF213348 Chrome Finish Shower Valve w/ 'D-Spud



4" Shower, Chrome, Teacup, Handles

4" Shower, Chrome, Plastic Cartridge, Teacup Handles



PF213343 4" Shower, Chrome, Teacup Handles



4" Shower Valve

The 4" shower valve faucet includes clear acrylic handles, chrome finish, brass or DuraPro underbody with D-spud for hand held shower.



PF213350 4" Chrome Shower Valve

PF213351 Shower Valve, 4", Chrome

PF223242 4" Shower Diverter - White



Exterior Shower

Perfect for outdoor showering, washing tools and utensils, fish cleaning and hundreds of other outside clean-up jobs. Features 59" reinforced hose, UV resistant case and security lock.



PF266201 Exterior Shower Box with 59" Vinyl Hose, 1/4 Turn, Plastic, White (377-1)

You Won't Believe It's Not Metal

The biggest faucet innovation in decades is available from Phoenix Products. We pioneered the use of plastic in faucets. And now we're excited to introduce the next big leap in faucet technology.

Get The Lead Out - Hybrid Faucets From Phoenix Metal Toughness - Plastic Economy

- New metal-plastic composite has the strength of brass and the corrosion resistance of economical plastic
- Drinking water never contacts metal
- Meets all State and Federal low lead and safe drinking water requirements
- WaterSense technology uses 20% less water than your old faucet without changing your water stream
- Single handle ceramic disc or two handle quarter turn washerless valves
- ADA compliant handles on all models



POWER RV SERIES
REMCO RV3200
 The ideal OEM replacement pump.



3.0 GPM
45 PSI
12 Volt DC

OEM replacement pump-
 An Exact OEM drop-in replacement, the 3200 is a heavy duty 3 chamber positive displacement diaphragm pump. It is self-priming and can be run dry. Includes fittings and inlet strainer.

Liquid Temperature: 140°F (60°C) Max
Amps: 10 Max
Max Pressure: 45 PSI (31 bar)
Flow Rate: 3.0 GPM / 12 LPM
Inlet/Outlet Ports: 1/2" NPT Male
Leads: 18 AWG, 4-1/2" Long

Weight: 48 lbs (104 kg)

- Quiet operation
- Low amp draw
- Easy connect fittings
- Industry standard mount pattern
- Build in check valve
- Capable of being run dry

90-3214-1C4-82L-SB

POWER RV SERIES
REMCO Rebel™

REMCO Professional Grade Pumps



3.2-5.3 GPM
60 PSI
12 Volt DC

FLO IQ INSIDE Eliminates Pump Cycling

The Price-Performance Leader -
 Engineered to withstand the most rigorous and punishing duty cycles, the REMCO™ Rebel™ Series Pump is a top-line performer.

Liquid Temperature: 140°F (60°C) Max
Amps: 13 Max
Max Pressure: 60 PSI Shut-Of
Flow Rate: 53 REBEL - 3.2 GPM / 12 LPM
 54 REBEL - 4.0 GPM / 15 LPM
 55 REBEL - 5.2 GPM / 20 LPM
Inlet/Outlet Ports: Remco Quick Attach - fittings included

Leads: 14 AWG, 12" Long
Weight: 8 lbs (3.6 kg)

- No Cycling
- Outlet check valve prevents back flow
- High performance 60 PSI, 13 Amps Max
- Self-priming
- Capable of being run dry

53 REBEL-JRV
54 REBEL-JRV

POWER RV SERIES
REMCO AquaJet™

REMCO Professional Grade Pumps



3.4 to 5.3 GPM
65 PSI
12 Volt DC

MADE IN AMERICA

Super Smooth Digital Flow Control-
 With years of field proven reliability, it's patented variable speed technology and five chamber design, the REMCO™ PowerRV™ AquaJet™ has earned a reputation as the finest and most advanced RV water system pump on the market.

Liquid Temperature: 140°F (60°C) Max
Amps: 10 Max
Max Pressure: 65 PSI
Flow Rate: AES - 3.4 GPM / 13 LPM
 ARV - 5.3 GPM / 20 LPM
Inlet/Outlet Ports: Remco Quick Attach - fittings included

Leads: 14 AWG, 12" Long
Weight: 3 lbs (3.6 kg)

- Low Voltage Shut-off
- Self-priming
- Capable of being run dry
- **Quietest pump on the market**

55 AQUAJET-AES
55 AQUAJET-ARV



SEWER & SANITATION

SEWER & SANITATION



Starter Kit w/ Water Regulator



K88121 Kit includes toilet paper, electrical adapter, drinking water hose, toilet treatments, drain hose, disposable gloves



EZ Coupler Bayonet Kits & Extensions



D04-0113 EZ Coupler Extension Hose, 10', Boxed
D04-0115 EZ Coupler Deluxe Bayonet Sewer Hose Kit, 20', Boxed



Viper Sewer Hose Kit



UV and puncture resistant, rotating fittings prevent kinks, and it stays flexible down to -30°F

D04-0450 Viper Sewer Hose Kit, 15', Boxed
D04-0475 Viper Sewer Hose Kit, 20', Boxed



Viper Extension Hose



UV and puncture resistant, rotating fittings prevent kinks, and it stays flexible down to -30°F

D04-0410 Viper Extension Hose, 10', Boxed



Dominator Sewer Hose Kits and Extensions



Rotating fittings prevent hose from twisting and pulling away from valve and sewer connection

- Holds its shape after installation
- Protection from leaks - UV stabilized poly construction
- Collapses for easy storage (from 15' to 57")

D04-0250 Dominator Sewer Hose Kit, 15', Boxed
D04-0275 Dominator Sewer Hose Kit, 20', Boxed



EZ Flush Heavy Duty with Sizing Rings



EZ Flush RV drain hose with sizing rings & 15 mil vinyl cover

D04-0012 EZ Flush Heavy Duty Drain Hose, 10', Bronze, Boxed
D04-0040 EZ Flush Heavy Duty Drain Hose, 20', Bronze, Boxed



Quick Drain Standard with Adapter



D04-0120PB Quick Drain Hose, Standard, 10', With Straight Hose Adapter, Blue, Bagged



Slunky Sewer Hose Support



- Deep pocket design provides enhanced stability
- Allows the hose to be curved around any obstacle while maintaining proper elevation for best drainage
- Compact, light and easily stored

S1000 Slunky Hose Support, 10', Boxed
S1000L0 Slunky Hose Support, 10', Low, Boxed
S1500 Slunky Hose Support, 15', Boxed
S2000 Slunky Hose Support, 20', Boxed
S2500 Slunky Hose Support, 25', Boxed



Rotating Wye

- Joins two outlet hoses to one sewer hose line
- Used when unit has two separate tank valves
- Rotating bayonet ends ensure that hose lays flat
- 4 durable hooks



F02-2030 Rotating Wye, 3", Bulk



Bayonet Fitting

Create an extension hose with two EZ Coupler parts (F02-3101 and F02-3108) that connect with a quick snap.



F02-3108 EZ Coupler Bayonet Fitting, Red, Carded



Flanged Valve Fittings



Slip hub 3".

T1005 3" Hub



Valve and Hose Adapter

Adapts drain hose to valve system with four bayonet attachments for a leak proof seal. Twist right onto your RV sewer hose



F02-3101 EZ Coupler Valve Adapter, Red, Carded



EZ Coupler 90

- Universal threaded sewer fitting with a standard bayonet end
- 6 different types of sewer connections with a gas tight fit
- Quick twist attachment
- Threads are 3", 3-1/2", and 4"



F02-3112 EZ Coupler 90° Bayonet Sewer Fitting, Red, Carded



Caps and Accessories



T1020 Waste Valve Cap, 3", Black, Bulk

T1020-1 Waste Valve Cap, 3", 3/4" GHT with Cap, Black



Coupler

- Connects two hoses together by simply threading on



F02-3102 EZ Coupler, Red, Carded



RV Hydroflush

- Breaks up plugged tanks, cleans tank, pipe, valve, drain hose
- Includes an internal backflow preventer and removable anti-siphon valve



F02-4100 RV Hydroflush 45°



Hose Adapters

- Fits all standard black waste valve systems
- Use with 3" clamp
- Santoprene® seal for leak proof connections



T1024 Hose Adapter, 3" Straight, Black, Bulk



90° Elbow

Multi-tiered sewer fitting press fits into sewer outlets for fast and easy set up. Two piece design allows hose to remain attached for easy storage. 3/4" threaded connector for 2nd gray water tank. Drip Cap included



F02-3103 EZ Coupler Universal Sewer Adapter, Red, Carded



Clear Hose Adapters

Clear so you know when your tank is clean. Easy bayonet attachment. No need to remove or re-attach drain hose for use with current drain hose fittings. 45° design reduces stress on sewer hose



T1026-1 Clearview Adapter, 45°, with 3" Bay Lugs



Rotating Rigid Pipe Adapter

- Rotates for easy connection
- Connects RV waste outlet to 3" male pipe thread



T1027 Rotating Rigid Sewer Pipe Bayonet Adapter, 3" Male Thread x Bayonet Hooks



SEWER & SANITATION



Galvanized Steel Hose Clamps

- For 3" drain hose
- 1/2" band



H03-0058 Hose Clamp #48, Zinc Plated, 2-1/2" x 3-1/2", Boxed



Bladex Body

- Fits Bladex, Valterra, Bristol and Anonda valves
- Includes seals, nuts and bolts



T1001VP Bladex Waste Valve Body, 1-1/2", Carded



Bladex Handle



Metal Valve Handle - Carded

T1003-6MPV Carded Metal Valve Handle



Bladex

- Fits Bladex, Valterra, Bristol and Anonda valves
- Includes seals, nuts and bolts



T1003VP Blade Waste Valve Body, 3", Carded

T1003VPM Bladex Waste Valve Body, 3", Metal Handle, Carded



Twist On Valve

- No more mess with an old valve problem. Twists onto your current waste valve



T58 Twist On Waste Valve, Boxed



Horst Miracle Probes



Prevents false readings:

- Horst Miracle Probes are considerably longer than standard probes and protected from liquid residue or sludge setting up a conductive path, or toilet paper from creating a false probe contact and related reading
- Additional Features:

- Easy to install as they fit the 3/8" diameter holes of existing probes
- Compatibility with existing wiring and monitors

T21301 Horst Miracle Probes, For Black Water Tanks, Bulk



Softness Toilet Tissue



- 2-Ply sheets
- Safe for septic systems
- Ensures a clog-free RV tank
- Tested for rapid breakdown

Q23630 Toilet Tissue, 4 pk



Totes

Transports Waste from Your RV/Trailer: Allows you to transport waste from your RV or trailer to a dump station;

Includes: (1) tote tank, (2 or 4) oversized wheels, (1) tank rinser, (1) ladder hook, (1) 3-foot, super heavy-duty sewer hose with swivel bayonet and lug fittings, (1) 15-inch female to female orange Rhino grey water hose, (1) clear elbow with a 4-in-1 adapter, (1) clear double bayonet elbow, (3) storage caps, (2) caps with lanyards for rinse connections and (1) steel tow adapter

Easy to Transport: Large, heavy-duty, no-flat wheels with bearings make transport smooth and effortless. A removable steel tow adapter allows you to easily roll the tote tank like a suitcase, or tow it slowly behind a truck or golf cart; Integrated Ladder Hook: Can sturdily clamp on to RV or camper ladder when not in use and the body of the tote tank features grooves to securely strap it in place

Simple to Clean: The low drain hole ensures that the tote tank empties completely. The smooth interior is easy to wash off using the integrated tank rinser

Rhino Portable Holding Tank - 2 Wheel



39000 15 Gal Holding Tank

39002 21 Gal Holding Tank

39004 28 Gal Holding Tank

39006 36 Gal Holding Tank

Rhino Portable Holding Tank, Steerable Wheels - 4 Wheel



39005 28 Gal Holding Tank

39007 36 Gal Holding Tank

JACKS & LEVELERS

Trailer Tech

Leveling Scissor Jack Kit



5000lb load capacity. Adjustable from 4" to 24" vertical. Bearing set on crank side for longer jack life. Universal bolt-on or weld-on application. Rust resistant black coating

TJSC-24K Jacks (2) w/ Handle & Bolts (8), Boxed

Trailer Tech

Leveling Scissor Jack



2500lb capacity per jack. Adjustable from 4" to 24" vertical. HANDLE SOLD SEPARATELY.

TJSC-24 Leveling Scissor Jack, Bulk (non-boxed)



TJSC-24-HD Jack Handle



Scissor Jack



5000lb capacity per Jack

285325 24" Scissor Jack (x1)

285326 24" Scissor Jack (2) w/ Handle

285344 30" Scissor Jack (2)

STRONG & RELIABLE RAM

Power Tongue Jack



3500lb load capacity. 25-1/8" lift. Comes in black and white.

EJ-3520BBX 3500-Lb PT Jack - black

EJ-3520WBX 3500-Lb PT Jack - white

VILTERA

Wheel Stop



- Attached handle interlocks with stackers
- Rugged tread design, stops RV at the top of the stack

A10-0922 Stackers Chock, Bulk

VILTERA

Wheel Chock



- Prevents tires from rolling and sliding
- Grooved surface for better grip
- Nylon cord to easily remove the chock when finished

A10-0908 Wheel Chock, Red, Bulk

VILTERA

Stackers



- Multi-use leveler, jack stand and tongue wheel support
- Attached easy to grip handle acts as a transition to the next step for a smooth ramp
- Convenient self-fastening strap for storage

A10-0916 Stackers, 4pk, Boxed

A10-0918 Stackers, 10pk, Boxed

A10-0920 Stackers, 10pk With Bag, Boxed



THE BEST AIR SPRINGS RIDE ON AIR

Firestone Ride-Rite™ Air Springs ride on air only to give you comfort, confidence and control.

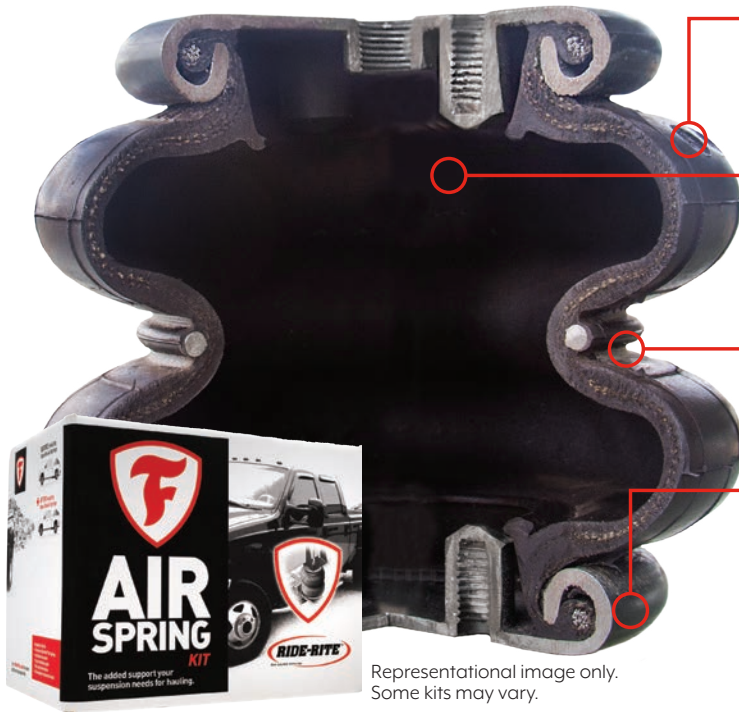

Representational image only. Some kits may vary.

ABSORBS EXTREME SHOCK

Capable of withstanding sudden left-to-right or side-to-side changes in suspension travel.

AIR ONLY DESIGN

Smooth ride and high performance because we only use air. No stroke limiting bumper required.

WORRY-FREE MAINTENANCE

Durable bellow won't rip or pull apart when suspended on a lift.

LONG PRODUCT LIFE

Built to last using commercial grade steel plates with rolled crimp design, for a long life under your truck.

TOP SELLING RIDE-RITE™ KITS			
Model	Year	Air Leveling Rear Kit	No Drill Install
Chevrolet/GMC Pickup Trucks			
Silverado, Sierra 1500 (2WD, 4WD)	19-22	2609	☑
Silverado, Sierra 1500 (2WD, 4WD)	07-18	2430	☑
Silverado, Sierra 2500/3500 HD (2WD, 4WD)	11-22	2613	☑
Silverado, Sierra 2500, 3500 (2WD, 4WD)	01-10	2250	☑
Dodge/Ram Pickup Trucks			
RAM 1500 (2WD, 4WD)	02-08	2286	☑
RAM 2500 (2WD, 4WD)	14-22	2598	☑
RAM 2500 (2WD, 4WD)	03-13	2299	☑
RAM 3500 (2WD)	14-22	2616	☑
RAM 3500 (4WD)	13-22	2615	☑
RAM 3500 (2WD, 4WD)	03-12	2299	☑

Model	Year	Air Leveling Rear Kit	No Drill Install
Ford Pickup Trucks			
F150 2WD, 4WD (not Raptor or FX2)	15-22	2582*	☑
F150 2WD, 4WD (not Raptor or FX2)	09-14	2525	☑
F150 2WD, 4WD (with B&W hitch)	09-14	2542	☑
F250/F350 (4WD SRW)	17-22	2620	☑
F250/F350 (4WD DRW)	17-22	2624	☑
F250/F350 (2WD)	17-22	2600	☑
F250/F350 (2WD, 4WD)	11-16	2597	☑
F250/F350 (2WD, 4WD)	08-10	2550	☑
Toyota Pickup Trucks			
Tundra (2WD, 4WD) TRD	07-22	2445	☑
Tacoma (4WD)	05-22	2407	☑
Tacoma Prerunner (2WD)	05-22	2407*	☑
Tacoma (2WD)	05-22	2410*	☑

*See application guide for specific fitment requirements

SUSPENSION, STABILIZATION, TIEDOWNS, SLIDE-OUT REPAIR

BEFORE installing Ride-Rite air springs

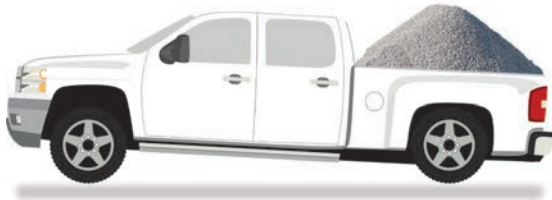

AFTER installing Ride-Rite air springs

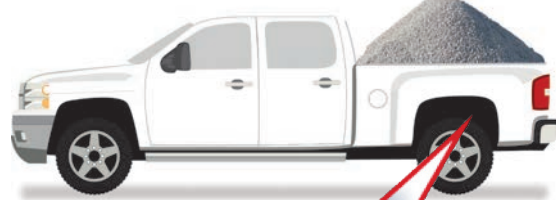

GO EXTREME.

Need power for frequent, extreme hauling? Ride-Rite™ Extreme Duty Air Springs were made with you in mind. Up to 150psi and leveling loads up to 7500lbs.*

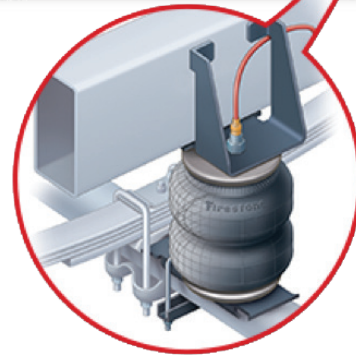

RED LABEL AIR SPRING KITS		
Make/Model	Year	Air Leveling Rear Kit
Chevrolet/GMC Pickup Trucks		
Silverado/Sierra 2500/3500 HD (2WD, 4WD)	11-22	2709
Silverado/Sierra 2500/3500 (2WD, 4WD)	01-10	2700
Ford Pickup Trucks		
F250/F350 (4WD, SRW)	17-22	2712
F250/F350 (4WD, DRW)	17-22	2713
F250 (2WD, 4WD)	11-16	2703
F350 (2WD, 4WD)	11-16	2703
F450 (2WD, 4WD)	11-13	2703
Ram Pickup Trucks		
Ram 2500 (2WD, 4WD)	14-22	2706
Ram 2500 (2WD, 4WD)	03-13	2701
Ram 3500 (4WD)	13-22	2710
Ram 3500 (2WD, 4WD)	03-12	2701

* Do not exceed the vehicle's recommended Gross Vehicle Weight Rating (GVWR)

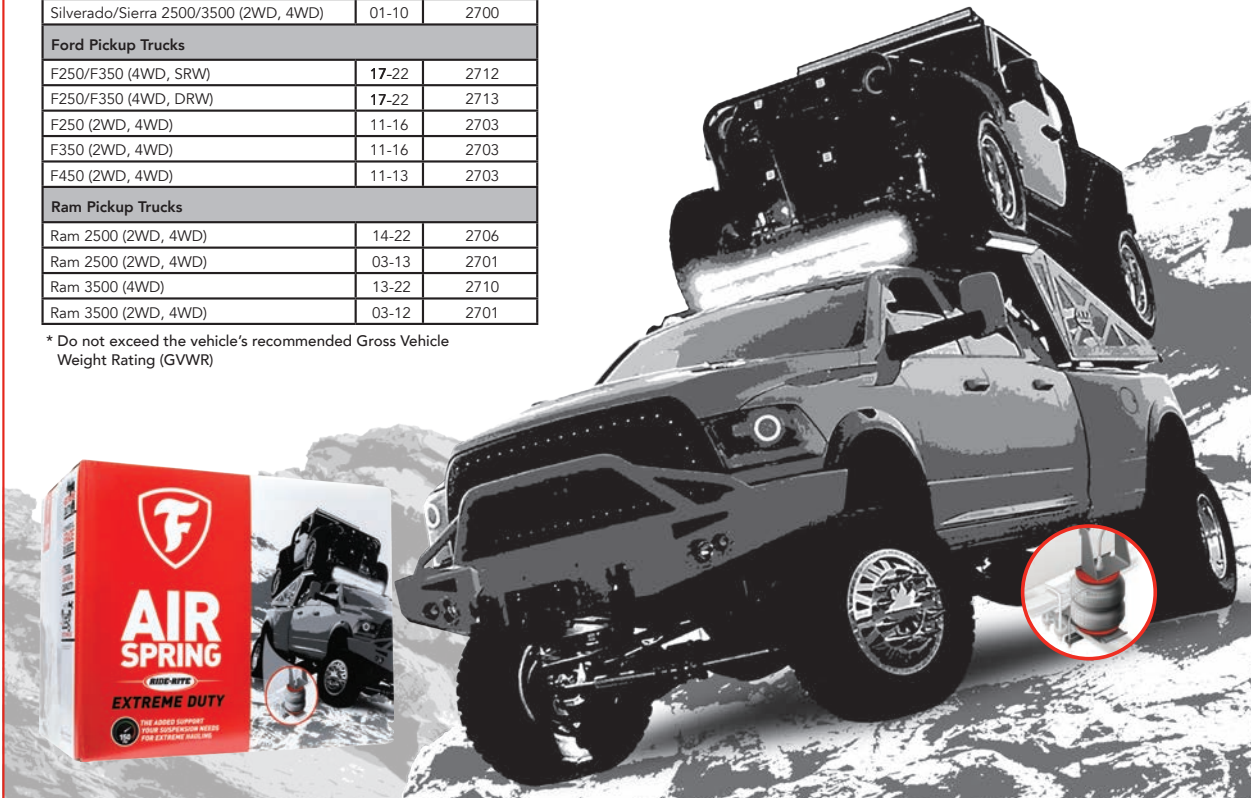

SUSPENSION, STABILIZATION, TIEDOWNS, SLIDE-OUT REPAIR

ON BOARD AIR FOR YOUR AIR SPRINGS

AIR COMMAND™ AIR CONTROL SYSTEMS

Firestone Ride-Rite™ Air Accessories enable you to adjust your air springs with the push of a finger.



Analog Mount



Wireless Remote

NEW! Wireless App

- New design with a two wire hook-up
- App for Apple & Android
- Mount anywhere compressor & ECU
- 2 memory presets



+ COMPATIBLE WITH MOST AIR SPRING SYSTEMS

+ CONVENIENT ONBOARD AIR

+ ONE PUSH PRESSURE ADJUSTMENT

+ PRECISION ENGINEERED LEVELING

		Light Duty	Standard Duty	Heavy Duty	Xtra	Xtreme
Single Leveling System Equal pressure to the springs on both sides. This applies to most towables using a hitch.	Analog	2538 2497*	2158 2497*	2097 2497*	2266 2497*	2543
	Wireless App	2610 Universal fit for all vehicles. Compatible with any air spring kit that uses 1/4" tubing.				
Dual Leveling System Allows for side-to-side or front-to-back leveling. This applies to work trucks, in-bed campers and off-center loads.	Analog	N/A	2178 2497*	2219 2497*	2168 2530*	2549
	Wireless	2581 2588*	2589 2588*	2590 2588*	2591 2588/2496*	2592 2588/2496*

Mounting plate for vehicle pairs with kit number

SUSPENSION, STABILIZATION, TIEDOWNS, SLIDE-OUT REPAIR

SUSPENSION, STABILIZATION, TIEDOWNS, SLIDE-OUT REPAIR

TAKE BACK CONTROL

With StableLoad Suspension Stabilizer



THE BEST SUSPENSION UPGRADE FOR YOUR VEHICLE

STABLELOAD

Suspension Stabilizer

Dramatically Improves Safety, Handling, Side-to-Side Sway and Eliminates Sag

Quad contact design complements the vehicle's specially engineered suspension that automotive manufacturers have invested millions of dollars designing, while all other rear suspension products reduce contact to only two points. Works with any vehicle that has an upper or lower overload leaf spring.



YEAR	MAKE/MODEL	MFG#	6 ROBS#	MFG#	6 ROBS#
UNIVERSAL		LOWER OVERLOAD		UPPER OVERLOAD	
Universal	Truck/SUV/Van/RV/Commercial, etc	A7311 (2,4)	TCWA7311	A7202 (3)	TCWA7200
FORD					
10-17	F150	A7310 (1,4)	TCWA7310	-	-
17-18	F250/350	A7311 (2,4,5)	TCWA7311	A7200 (3)	TCWA7200
DODGE					
13-17	3500	A7311 (2,4,8)	TCWA7311	A7200 (3,8)	TCWA7200
2018	F250	A7311 (2,4)	TCWA7311	-	-
CHEVROLET/GMC					
15-17	1500 trucks	A7310 (1,4,7)	TCWA7310	-	-
16-18	3500 trucks	A7310 (1,4)	TCWA7310	A7202 (3)	TCWA7202
88-18	2500 trucks	A7310 (1,4)	TCWA7310	-	-
17-18	1500 trucks (5.5ft & 6.5 ft bed ONLY)	A7310 (1,2)	TCWA7310	-	-
TOYOTA					
All	Tacoma	A7311 (2,4)	TCWA7311	-	-

For footnotes and 1980-2019 fitments visit torklift.com



SUSPENSION, STABILIZATION, TIEDOWNS, SLIDE-OUT REPAIR

SUSPENSION, STABILIZATION, TIEDOWNS, SLIDE-OUT REPAIR

OUTFIT YOUR TRUCK CAMPER With Torklift Tie Downs and Turnbuckles

FRAME MOUNTED STEEL CAMPER TIE DOWNS

Improve vehicle handling and stability
Avoid bed and bumper damage
No-drill application



FRAME MOUNTED STAINLESS STEEL & ALUMINUM TALON TIE DOWNS

100% military grade aluminum
Up to 50% lighter than steel tie downs on most applications
No-drill applications



For footnotes and 1980-2019 fitments visit torklift.com

	Year	Model	Cab	Bed	Front Tie Downs			Rear Tie Downs		
					Do running boards extend past the cab?	Standard Front Tie Down	Talon Aluminum Front Tie Down	Your current receiver / trailer hitch	Standard Rear Tie Down	Talon Aluminum Rear Tie Down
FORD	17-18	F250, F350	Super Crew, Super Cab	6.75ft	No	F2022		Factory	F3008	
		Super Duty W/ factory bed						SuperHitch Magnum	TCWR3504	R3504A
	2018	F150	Super Cab	8ft	No	F2032		Aftermarket	TCWR3500	
DODGE/RAM	2018	F250, F350	Super Crew, Super Cab	8ft	No	F2021	F2021A	None / Factory	F3007	
		Super Duty W/ factory bed				Yes	F2021	F2021A	Factory	F3008
	2014-2018	2500	Crew	6.5ft	No	D2126	D2126A	No Hitch	D3109	D3109A
					Factory running boards	D2127	D2127A	Factory	D3109	D3109A
		Dual Rear Wheel						SuperHitch	R3507	R3507A
								SuperHitch Magnum	R3507	R3507A
	2018	3500	Crew, Mega	6.5ft	No	D2130	D2130A	No Hitch	D3109	D3109A
					Yes	D2132	D2132A	Factory	D3109	D3109A
	Single Rear Wheel						SuperHitch	R3507	R3507A	
							SuperHitch Magnum	R3507	R3507A	
2018	3500	Crew	8ft	No	D2124 (1,2)	D2124A (1,2)	No Hitch	D3109	D3109A	
				Cab length	D2127	D2127A	Factory	D3109	D3109A	
							SuperHitch	R3507	R3507A	
							SuperHitch Magnum	R3507	R3507A	
CHEVROLET	2017-2018	3500	Crew	8ft	No	C2219	C2214A	Aftermarket	TCWR3500	
					Factory	C3217	C3217A	SuperHitch	C3216	C3216A
	Dual Rear Wheel						SuperHitch Magnum	C3216	C3216A	
							Aftermarket	TCWR3500		
	2018	3500	Double	8ft	No	C2222	C2214A	No Hitch	TCWR3500	
					Yes	C4204		Factory	C3215	C3215A
						SuperHitch	C3216	C3216A		
						SuperHitch Magnum	C3216	C3216A		
2018	2500	Double	8ft	No/ Cab length	C2222		Factory	C3215	C3215A	
				Yes	C4204		SuperHitch	C3216	C3216A	
										SuperHitch Magnum

Footnotes

1. Due to compressor location this Tie Down can't be installed with factory airbag
2. If your truck is equipped with factory airbags and no running boards, use D2126. If your truck is equipped with factory airbags and running boards of any length, use D2127

FASTGUN TURNBUCKLES

Connects and disconnects in seconds
Spring-loaded design
Secure your camper with ease
100% tool free
100% lockable
100% stainless steel



FastGun Locks

FastGun Long Range (25" - 43")

BrightWhite TCWS9530
Hammertone Grey TCWS9522
Polished Stainless Steel TCWS9526
Black TCWS9529

FastGun Short Range (14 1/2" - 21 1/2")

BrightWhite TCWS9521
Hammertone Grey TCWS9520
Polished Stainless Steel TCWS9527
FastGun Locks TCWS9500

SPRINGLOAD XL TURNBUCKLE

Built in spring tension indicators
Reaches from 25" to 45"
Can be used with Derringer Handles to convert into quick disconnect

Part # TCWS9050A

BASIC SPRINGLOAD KIT TURNBUCKLE

Adjusts in minutes
Built-in spring tension indicators
Protects truck from frame damage

Part # TCWS9000



SUSPENSION, STABILIZATION, TIEDOWNS, SLIDE-OUT REPAIR

dicor products
An AIRXCEL Brand
the rv wheel experts

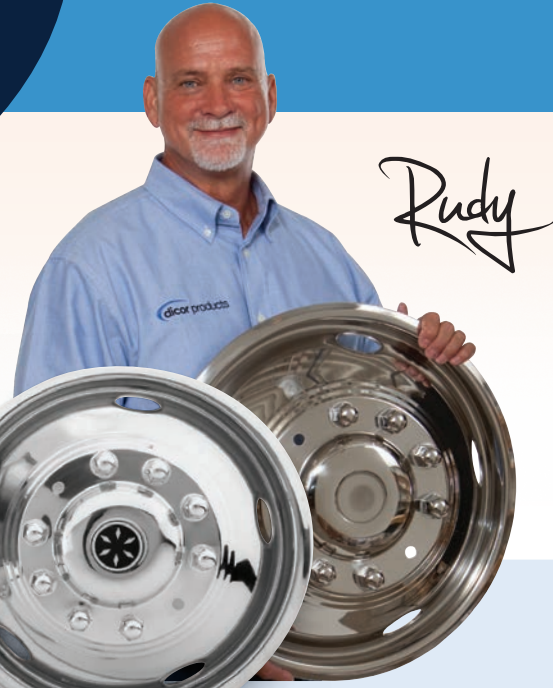

The brand more OEMs trust than all others combined.

- Versa Liners®
- Airgard Inflation Systems
- Fastliners Wheel Covers



VERSA LINER® STAINLESS WHEEL SIMULATORS

With over 1 million sets in service, the Versa Liner® from Dicor is the choice of more motorhome manufacturers than all other brands combined. No need to remove lug nuts or use jacks, a complete set can be installed in about five minutes. The Versa Liner® is made of tough 304L stainless steel with permanently attached simulated lug nuts, designed for years of durable service. Highly polished and maintenance-free, Versa Liners® will not rust, corrode, flake or peel. Rolled edges for tire and handling safety. The Versa Liner® attaches securely with a road proven design that stays on even in the roughest conditions. Limited 5-year warranty. Other Versa Liners® are available to fit wheels not listed. For details visit www.dicorproducts.com.

FORD			
PART NO.	DICOR NO.	SIZE	YEAR LUGS SPECIAL
V160F2		16"	'92 to '97-1/2 8 Lug, 8 Hand Hole (28618, 29317*)
V160F7		16"	'97-1/2 to 3/'07 8 Lug, 8 Hand Hole (28618, 29317, 29315*)
V160F0		16"	'84-1/2 to '98 8 Lug, 4 Hand Hole (28333, 28511*)
V160F8		16"	'99 to '02 8 Lug, 4 Hand Hole (29348*)
V160F8M**		16"	'03 to '04 8 Lug, 4 Hand Hole (29348*)
V160SD		16"	'88 to '98, Super Duty 10 Lug, 4 Hand Hole (28375, 28513, 28671*)
V170F5		17" x 6-1/2"	'05 to Current, Super Duty 8 Lug, 4 Hand Hole (29837*)
V195F96		19-1/2" x 6"	'99 to '02, Super Duty 8 Lug, 5 Hand Hole (29186*)
V195F96M**		19-1/2" x 6"	'03 to '04, Super Duty 8 Lug, 5 Hand Hole (29186*)
V195F66M**		17" x 6"	'06 to Current, Super Duty 10 Lug, 5 Hand Hole (29883, 29884, 29839*)
V195F9		19-1/2" x 6-3/4"	'99 to '02, Super Duty 8 Lug, 5 Hand Hole (29236*)
V195F9M**		19-1/2" x 6-3/4"	'03 to '04, Super Duty 8 Lug, 5 Hand Hole (29236*)
V195F6M**		19-1/2" x 6-3/4"	'06 to Current, Super Duty 10 Lug, 5 Hand Hole
V22553		22-1/2"	'06 to Current 8 Lug, 8 Hand Hole (29028*) Chevrolet/GMC

FREIGHT LINER/OSHKOSH/SPARTAN/JOHN DEERE & HD WHEELS			
DICOR NO.	SIZE	YEAR	LUGS SPECIAL
V19582	19-1/2"	'98 to Current	8 Lug, 4 Hand Hole (28680, 28612, 28 532*)
V22506	22-1/2" x 6-3/4"	'92 to Current	6 Lug, 6 Hand Hole (28157*)
V22501	22-1/2" x 7-1/2"	'97 to Current	10 Lug, 5 Hand Hole (29001*)
V22587	22-1/2" x 8-1/4"	'99 to Current	10 Lug, 5 Hand Hole (28487* and Maxion W0003684)
V22553	22-1/2"	'07 to Current	8 Lug, 8 Hand Hole (29028*)

CHEVROLET/GMC/WORKHORSE			
DICOR NO.	SIZE	YEAR	LUGS SPECIAL
V160G4	16" x 16-1/2"	'73 to '02	8 Lug, 4 Hand Hole (28177, 28374, 28603, 28623, 27993, 27995*)
V195P5	19"	'77 to Current P32	10 Lug, 5 Hand Hole (27775*)
V22569	22-1/2" x 6-3/4"	'99 to Current	8 Lug, 4 Hand Hole (28869* and Maxion W0002403)
V22587	22-1/2" x 8-1/4"	'99 to Current	10 Lug, 5 Hand Hole (28487* and Maxion W0003684)
V22501	22-1/2" x 7-1/2"	'97 to Current	10 Lug, 5 Hand Hole (29001*)

* Accuride Wheel Numbers are given in brackets. Numbers are stamped on the wheel for easy identification. Other Versa Liners available by special order to fit wheel numbers not listed.

** Metric fine thread Jam Nut

SUSPENSION, STABILIZATION, TIEDOWNS, SLIDE-OUT REPAIR



WHEELS



STAINLESS STEEL WHEEL COVERS

Enhances the appearance of any vehicle. The durability of 304L stainless steel virtually eliminates rust or staining and provides long lasting, maintenance free performance. Features a road proven attachment system. Used by more RV manufacturers than all other brands. Installation is quick and easy. Includes attachment hardware. Will not fit Budd wheels or split rims. *4/box. **1/box (cover only).

STAINLESS STEEL WHEEL COVERS

DICOR NO.	SIZE	YEAR	LUGS SPECIAL
SHFM16*	16"	Single or Dual Wheel (Including '92 Ford)	8 Lug
SHFM65*	16-1/2"	Single or Dual Mounted Wheels	8 Lug
SHSD16*	16"	Universal (Including Ford Super Duty)	10 Lug
SHAG95*	19-1/2"	Chevy, GMC, P-30	10 Lug
SHFM16-COV**	16"	Single Wheel Cover	
SHFM65-COV**	16-1/2"	Single Wheel Cover	
SHAG95-COV**	19-1/2"	Wheel Cover (Front and Rear Brackets Sold Separately)	



FASTLINER SERIES SIMULATORS

Great looking stainless steel simulators combine Dacor's retention system with the attractive styling of a liner. One-piece construction features permanently attached stainless steel lug nut covers – no loose parts, no assembly and no lug nut removal. Superior contoured styling features protective rolled edges for added strength and handling safety. Will not fit Budd wheels or split rims. 5-year limited warranty.

FLS SERIES

DICOR NO.	SIZE	YEAR	LUGS SPECIAL
TAC545-CC	16"	Fits Most 16" Truck, Van and Trailer Single Wheels	8 Lug

FL SERIES

DICOR NO.	SIZE	YEAR	LUGS SPECIAL
FL60-59	16"	'07 to Current, E-350/E-450 std. Universal	8 Lug
FL62	16"	'92 - '03/'07 E-350/E-450 (Accuride# 28618)	8 Lug, 8 Hand Hole
FL65	16-1/2"	Std. Standard Universal Ford, Chevy and Dodge	8 Lug
SHSF1608	16"	'08 to '11 Sprinter	
SHSF1612	16"	March '12 to Current	



VERSA-LOK® ABS HUB COVERS

Update your trailer's appearance with the best retention system ABS Hub Covers on the market today! The Versa-Lok® patented locking system, locks onto the wheel with a simple twist, allowing easy access to your trailer wheel hubs without prying them off. No tools necessary for installation or removal. Priced each.

VERSA-LOK® ABS HUB COVERS

DICOR NO.	SIZE	YEAR	LUGS SPECIAL
TAC545-CC	4-1/2"	5 Lug, Chrome	8 Lug
TAC655-CC	5-1/2"	6 Lug, Chrome	8 Lug, 8 Hand Hole
TAC865-CB	6-1/2"	8 Lug, Chrome	8 Lug



WHEEL COVER PARTS

DICOR NO.	DESCRIPTION
SHAU95-CAP	Center Cap for 19-1/2" Wheel Covers
SHAU-LNC	Simulated Lug Nuts



RIGHT STUD EXTENDER

Use on Versa Liner® stainless steel wheel simulators Ford 96-8261. Stainless steel. Priced each.

DICOR NO.	DESCRIPTION
V160SD-STX	9/16" Right Stud Extender

JAM NUT

Use on the Versa Liner® stainless steel Ford wheel simulators. Stainless steel.

DICOR NO.	DESCRIPTION
V160SD-JNT	13/16" Single Jam Nut

ENCAPSALATED JAM NUT

Use on the Versa Liner® stainless steel wheel simulators. Stainless steel.



DICOR NO.	DESCRIPTION
V160F7-EJN	9/16" fits Ford Wheel Simulators
V195P7-EJN	5/8" fits Chevy, GMC, or Workhorse Wheel Simulators
V195F9-EJN	5/8" fits Chevy, GMC, or Workhorse Wheel Simulators

LUG NUT COVER

Use on Versa Liner® stainless steel wheel simulators. Stainless steel. Priced each.

DICOR NO.	DESCRIPTION
V160FO-LNC	1-1/16" Versa Liner® Single Lug Nut Cover



DECAL

Replacement center decal for Versa Liner® wheel simulators. Priced each.

DICOR NO.
2" Decal
2-3/4" Decal



An AIRXCEL Brand

**the components rvs
are born with!**

INFLATION

VHS SERIES INFLATION SYSTEM

The only 4-hose air system designed exclusively for Dicor's Versa Liner® Wheel Simulators. The Versa Liner® Hose System allows easy access to both inner and outer dual wheels for inflating tires or checking pressure. Flexible braided stainless steel protects a hydraulic hose that won't kink and form weak spots like rubber will. Hose sets mount easily to valve stems using stainless steel mounting brackets included. No drilling, pop-rivets or special tools required. Fits every time with no adjustment necessary.



VHS SERIES INFLATION SYSTEMS

PART NO.	DESCRIPTION
VHS-N3GC	16" to 16-1/2" GM Universal & 19-1/2" Chevy, 8 Lug. Also fits: 16", 19-1/2" & 22-1/2" Jam Nut Wheel Simulators

UNIVERSAL INFLATION SYSTEMS

Allows access to both inner and outer dual wheels for inflating tires or checking pressure. Fits most wheel simulators and wheel covers. Universal inflation systems include UHS.

UHS SERIES (NOT PICTURED)

THE UHS series contains two 125° Outer Dual Valve Extenders (AG-125) and two Inner Dual Valve Extenders (LS-734N) with stabilizers. Hydraulic hoses have stainless steel braid – heat treated to provide strength, flexibility and extra protection. Fits most wheel simulators and includes stabilizer brackets to keep hoses centered in hand holes for easy access. Set can be used for inner and outer dual wheels.

UNIVERSAL SERIES INFLATION SYSTEM

PART NO.	DESCRIPTION
UHS-4C	Universal Dual Wheel Inflation Set



SOLID VALVE EXTENDERS

Solid nickel plated brass valve extenders are angled to allow easier access to front tire valve stems on most vehicles. Can be used on plain wheels or with most stainless steel simulators. 2/card.

SOLID VALVE EXTENDERS

PART NO.	DESCRIPTION
AG-45-C	45° Front Tire
AG-125C	125° Outer Dual

VALVE EXTENDERS

Makes hard-to-reach inner dual valve stems easily accessible for proper tire inflation. A stabilizer bracket snaps into a hand hole to keep the extender centered for easy access.



LS SERIES

The LS series combines the strength and flexibility of a long-lasting hydraulic hose with the extra protection of heat treated stainless steel braid. The exclusive live stem inner core technology utilizes a floating valve stem that is activated only when air is added or removed from the tire. Hose fits every time. Installation requires no special adjustments and provides increased protection against tire deflation should the valve extender be damaged. For inner duals only. 2/pack.

LS SERIES INFLATION SYSTEMS

PART NO.	DICOR NO.	DESCRIPTION
LS-534N-12FC		16", '92 to Current Ford E-350, 8 Hand Hole. Also fits: 16", 16-1/2" & 19-1/2"; Most 22-1/2"
LS-734N-2FC		19-1/2"; '99 to Current Ford

	HYDRAULIC HOSE	REINFORCED NYLON HOSE	BRAIDED STAINLESS STEEL COVERING	LIVE STEM TECHNOLOGY	SET OF 4	SET OF 2	APPLICATION
HOSE SETS							
VHS Series	•		•		•		Versa-Liner
UHS Series	•		•		•		Universal
VALVE EXTENDERS							
LS Series	•		•	•	•		Universal
SOLID VALVE EXTENDERS							
AG45							• Universal
AG125							• Universal



SUSPENSION, STABILIZATION, TIEDOWNS, SLIDE-OUT REPAIR

SUSPENSION, STABILIZATION, TIEDOWNS, SLIDE-OUT REPAIR



In Wall Motor

Motor 42mm in wall
Mid torque w/brake
.343 D-Cut



364262 42 mm Mid Torque In Wall Slide Motor with Brake



In-Wall Motor



Current version of Schwintek motor.

236575 Schwintek In-Wall Slide Motor-Round Gearbox



Motor

Klauber C800 Motor - 1/6 HP used in assemblies 161453, 1917771, 272379, 300625, 300626, 299969, & 113407.



138445 Electric Stabilizer Jack 1/6 Hp Motor



High Torque Motor

MOTOR; IN-WALL;
HIGH TORQUE; 500:1



287298 High Torque 500:1 Motor; In-Wall® Slide-Out



Harness



HARNES; IN-WALL - 20 FT

229755 Schwintek Controller To Motor Harness; 20'

238991 Schwintek Controller To Motor Harness; 25'

229756 Schwintek Controller To Motor Harness; 30'



Roller

The In-Wall Slide-Out System has revolutionized the RV industry. All motors and mechanics are located in the slide walls and the patented aircraft-quality worm rail provides smooth and efficient slide room movement.



320500 J-38 Roller; In-Wall Slide-Out



Standard Bearing Block



379060 Standard Bearing Block Kit



Controller



Rev C-2

211852 Schwintek In-Wall Slide Controller



Gear Pack 2 x 2



2 x 2 slide-out gear pack, For use on LCI above-floor or through-frame slide-out. Gear pack does not include roll pin assembly.

281331 2 X 2 Slide-Out Standard Gear Pack



Gear Pack



Need a replacement gear pack for your LCI Through-Frame or Above-Floor Slide-Out? For use on LCI Above-Floor or Through-Frame Slide-Out. No assembly required
PLEASE NOTE: 15 tooth gear is included with your order. If you have an 18 tooth gear (Part Number: 122739) you will need to purchase that separately.

324869 Gear Packs for Slide-Out Mechanisms



Trombetta Solenoid

The Polarity Reversing Solenoid is primarily used on hydraulic leveling and slide-out units. Comes in silver. For reversing polarity of permanent magnet DC motors. No assembly required.



118246 Polarity Reversing Solenoid



Standard Trombetta Solenoid



Polarity Reversing Solenoid by Trombetta for Hydraulic Power Units

136046 Polarity Reversing Solenoid

SUSPENSION, STABILIZATION, TIEDOWNS, SLIDE-OUT REPAIR

SUSPENSION, STABILIZATION, TIEDOWNS, SLIDE-OUT REPAIR



Wear Tab



Universal to all LCI(tm) Slide-Out systems

103480 Lci(tm) Slide-Out Universal Wear Pad



Shoe/Lining Kit



136444 12" x 2" Brake Kit

136451 10" x 2.25" Brake Kit



Never Fail Bushing



281625 9/16" ID, 11/16" OD - 1-3/4"

2796851 French Double Axle, 14 Pk



Flexguard



All Flex Guard kits come with hardware, post and clips.

1346271 8" Single Flex Guard Kit

1346281 8" Double Flex Guard Kit

1346291 8" Triple Flex Guard Kit



Brake Spring/Hardware Kit



136445 12" x 2" Brake Spring/Hardware Kit

136452 10" x 2.25" Brake Spring/Hardware Kit

136453 Adjustment Screw Kit



Never Fail Shackle/Bolt Kit



Kit comes complete with Never-Fail bushings, shackle links, bolts and nuts for a tandem/double axle configuration

281285 Double Axle



Interior Switch

Universal for LCI(tm) Hydraulic Slide-Out Systems



120639 Hydraulic Slide-Out Interior Switch And Plate



Electric Brake Assembly



181935 12.25" x 3.38" LH Assembly

181935 12.25" x 3.38" RH Assembly



Strongarm Jack Stabilizer



For landing gear with over 58" between them, to eliminate unwanted chassis movement. Bolt on, permanent mounted kit. Comes with stabilizing tubes and mounting gear.

191023 JT Strongarm Jack Stabilizer 58"



Slide-Out Slicker

Every time your slide room extends and retracts it rubs your carpet just enough to create a worn-out spot over time. Slide-Out Slickers protect your carpet and keep it looking like new. Nearly 40 inches long. Comes in a two-pack



134993 Slide-Out Slicker



Electric Brake Magnet Kit



136447 Fits 12" Brakes



Strongarm Jack Stabilizer



Replaces standard snap-up chains in existing hitch systems for easier/safer towing experience. Works with every weight distribution hitch system except E-equal-izer

335852 JT Strongarm Jack Stabilizer 58"



Suspension Alignment Kit

Kit allows authorized Correct Track Service centers to correct axle alignment, allowing tires to run smooth.



87220 Correct Track II Alignment Kit



TOWING



Fifth Wheel Hitches 71-73
Gooseneck Hitches 74-75
Hitches and Ball Mounts 76-78



Brake Controls 79-81
Fifth Wheel Hitches 82-86
Weight Distributing 87-93
Ball Mounts & Accessories 94-113



Fifth Wheel Hitches & Accessories 114-124



Weight Distributing 125-128



Towing Products 129



Brake Controls 130-131



Superhitch 132



Tow Bars and Accessories 133-137



Mud Flaps 138



TPMS 139





THE PATRIOT



The **Patriot 18K Slider™** is our rail mounted hitch now available with 12 inches of slide for maneuvering a short-bed truck.

18,000 LB. GTW - 4,500 LB. VTW

Fits standard mounting rails

Cam-operated, machined jaws

Polyurethane bushings for a smooth, rattle-free tow

Height Adjustment 17"-19"

ITEM	DESCRIPTION
RVK3270	Patriot 18K Slider 5th Wheel Hitch



The **Patriot 18K™** is our rail mounted hitch with a one piece base design for easier installation and a higher tow rating.

18,000 LB. GTW - 4,500 LB. VTW

Fits standard mounting rails

Cam-operated, machined jaws

Polyurethane bushings for a smooth, rattle-free tow

Height Adjustment 16"-19"

ITEM	DESCRIPTION
RVK3255	Patriot 18K 5th Wheel Hitch



The **Patriot 16K™** is our rail mounted hitch. Designed as a less expensive, lighter-weight alternative to the Companion, with many of the same great features.

16,000 LB. GTW - 4,000 LB. VTW

Fits standard mounting rails

Cam-operated, machined jaws

Polyurethane bushings for a smooth, rattle-free tow

Height Adjustment 16"-19"

ITEM	DESCRIPTION
RVK3200	Patriot 16K 5th Wheel Hitch





COMPANION™ FOR FORD, GM & RAM PUCKS

The **Companion for Ford Pucks**, **Companion for Ram Pucks**, and **Companion for Chevrolet/GMC Pucks** have all the benefits that customers love about our Companion, but it's designed to work with the factory hitch platform. It uses the same cushioned coupler head as the original Companion, with cam operated jaws that eliminate binding. And it's removable, with no rails left in the bed when you're not towing.

- 20,000 LB. GTW - 5,000 LB. VTW - Ford Companion Hitches
- 20,000 LB. GTW - 5,000 LB. VTW - GM Companion Hitches
- 20,000 LB. GTW - 5,000 LB. VTW - Ram Companion Slider
- 25,000 LB. GTW - 6,250 LB. VTW - Ram Companion
- 25,000 LB. GTW - 6,250 LB. VTW - 25K Ford Companion
- 25,000 LB. GTW - 6,250 LB. VTW - 25K GM Companion
- Fits the factory hitch platform
- Cam-operated, machined jaws
- Polyurethane bushings for a smooth, rattle-free tow
- Height Adjustment 16 3/4"-18 3/4" - Ford Companion and Chevrolet/GMC Companion
- Height Adjustment 17"-19" - Ram Companion

PART #	DESCRIPTION
RVK3300	Companion 5th Wheel Hitch - Fits Ford Puck System
RVK3305	25K Companion 5th Wheel Hitch - Fits Ford Puck System
RVK3370	Companion Slider 5th Wheel Hitch - Fits Ford Puck System
RVK3600	Companion 5th Wheel Hitch - Fits Ram Puck System
RVK3670	Companion Slider 5th Wheel Hitch - Fits Ram Puck System
RVK3700	Companion 5th Wheel Hitch - Fits Chevrolet/GMC Puck System
RVK3705	25K Companion 5th Wheel Hitch - Fits Chevrolet/GMC Puck System
RVK3770	Companion Slider 5th Wheel Hitch - Fits Chevrolet/GMC Puck System





COMPANION™



The **Companion™** adored by RVers, was designed to address the issue of sloppiness in hitches. The result is a quiet, cushioned ride that is free of jerking. And it's removable. Free up your truck bed when you're not towing.

20,000 LB. GTW - 5,000 LB. VTW

Utilizes B&W's under bed mounting system

Cam-operated, machined jaws

Polyurethane bushings for a smooth, rattle-free tow

Height Adjustment 16 1/4" - 18 1/4"

Flatbed version rated at 22,000 LB. GTW, no height adjustment

ITEM	DESCRIPTION
RVK3500	Companion 5th Wheel Hitch
RVK3050	Companion Flatbed 5th Wheel Hitch



The **Companion Slider™** has all the benefits that customers love about our Companion, but adds the additional turning clearance you might need with a short-bed truck. It has an automatic latch in both directions and 12" of rearward travel. It uses the same cushioned coupler as the original Companion, with cam operated jaws that eliminate binding. And it's removable, with no rails left in the bed when you're not towing.

20,000 LB. GTW - 5,000 LB. VTW

Utilizes B&W's under bed mounting system

Cam-operated, machined jaws

Polyurethane bushings for a smooth, rattle-free tow

Height Adjustment 17" - 19"

ITEM	DESCRIPTION
RVK3405	Companion Slider 5th Wheel RV Hitch





BW
TRAILER HITCHES

TURNOVERBALL®

THE #1 SELLING GOOSENECK IN AMERICA.



- Solid, machined 2-5/16" ball
- Durable powder-coat finish
- Only a 4" hole in the bed
- Bolts to existing holes in the frame with no drilling or welding
- Solid, one-piece machined receiver socket
- Flexible latch pin handle attached to a spring loaded, 5/8" steel locking pin that goes completely through the ball
- Limited Lifetime Warranty

NEW! OEM Ball & Safety Chain Kit

For use with factory towing systems

- Handle provides leverage for operation and a clean way to carry the ball
- Handle locks in horizontal position to prevent accidental unlatching
- Internal and external components are plated or made from stainless steel for corrosion protection
- Safety chain anchors accommodate commercially available safety chain hooks



E O E	GNXA2061 71-8677	Ford, GM, & Nissan Titan
	GNXA2062 71-8678	Ram

Turnoverball® Gooseneck Hitch Fit List



	PART NUMBER	TRUCK YEAR, MAKE, AND MODEL
CHEVROLET GMC	GNRK1016	2016-2019 Chevrolet & GMC 2500 & 3500 Heavy Duty Trucks
	GNRK1012	2011-2015 Chevrolet & GMC 2500 & 3500 Heavy Duty Trucks
	GNRK1057	2007-2018 Chevrolet & GMC 1500 Short Bed Trucks with Boxed Frame
	GNRK1007	2007-2018 Chevrolet & GMC 1500 Long Bed Trucks with Boxed Frame
	GNRK1067	2001-2010 Chevrolet & GMC 2500 Heavy Duty Trucks 2007-2010 Chevrolet & GMC 3500 Trucks (With 1 bed cross member over the axle)
	GNRK1062	2001-2007 Chevrolet & GMC 3500 Trucks (With 2 bed cross members over the axle)
	GNRK1059	1999-2007 Chevrolet & GMC 1500 & 2500 Light Duty Trucks (Tube Frame changing to C-Channel before axle)
	GNRK1050	1988-1998 Chevrolet & GMC 1500, 2500 & 3500 Short Bed Trucks 1999-2000 Chevrolet & GMC 2500 & 3500 Short Bed Trucks (Full C-Channel Frame)
	GNRK1000	1988-1998 Chevrolet & GMC 1500, 2500 & 3500 Short Bed Trucks 1999-2000 Chevrolet & GMC 2500 & 3500 Heavy-Duty Long Bed Trucks (Full C-Channel Frame)
	GNRK1400	1973-1987 Chevrolet & GMC 1500, 2500, & 3500 Trucks (Requires Drilling)
FORD	GNRK1117	2017-2019 Ford F250 & F350 4-Wheel Drive Super Duty Trucks 2017-2019 Ford F450 4-Wheel Drive Super Duty Trucks with factory installed bed
	GNRK1116	2017-2019 Ford F250 & F350 2-Wheel Drive Super Duty Trucks
	GNRK1111	2011-2016 Ford F250 & F350 Super Duty Trucks 2011-2016 F450 with Factory Installed Bed
	GNRK1115	2015-2018 Ford F150 Trucks
	GNRK1104	2004-2014 Ford F150 Trucks
	GNRK1108	1999-2010 Ford F250 & F350 Trucks 2008-2010 F450 with Factory Installed Bed
	GNRK1197	1997-2003 Ford F150 & Light Duty F250 Trucks, & 2004 Heritage Edition
	GNRK1100	1980-1998 Ford F250 & F350 Without Overload Springs
	GNRK1110	1980-1998 Ford F250 & F350 With Overload Springs (Requires Drilling 2 Holes)
	GNRK1150	1980-1996 Ford F150 Trucks
DODGE RAM	GNRK1314	2013-2018 Ram 3500 Trucks
	GNRK1384	2014-2018 Ram 2500 Trucks
	GNRK1319	2019 Ram 1500 Model DT Gas Engine Trucks
	GNRK1309	2009-2018 Dodge/Ram 1500 Trucks *Only GNXA4685 and RVK3500 with special post work with this hitch
	GNRK1313	2013 Ram 2500 Diesel Trucks 2010-2012 Ram 2500 & 3500 Diesel Trucks 2003-2009 Dodge 2500 & 3500 Gas or Diesel Trucks
	GNRK1308	2013 Ram 2500 Gas Engine Trucks 2013 Ram 2500 Mega-Cab Trucks 2010-2012 Ram 2500 & 3500 Gas Engine Trucks 2006-2012 Dodge/Ram 1500, 2500, & 3500 Mega-Cab Trucks
	GNRK1316	2002-2008 Dodge 1500 Trucks (Except Mega-Cab)
	GNRK1394	1994-2002 Dodge 2500 & 3500 Trucks 1994-2001 Dodge 1500 Trucks
	GNRK1300	1973-1993 Dodge 1500, 2500 & 3500 Trucks (Requires Drilling)
	GNRK1257	2007-2018 Toyota Tundra All Beds *Only GNXA4585 and RVK3500 with special post work with this hitch
OTHER	GNRK1251	2000-2006 Toyota Tundra All Beds
	GNRK1208	2004-2018 Nissan Titan Does Not Include Titan XD
	GNRK1217	2017-2018 Nissan Titan XD Model S Trucks
	GNRK1500	Flatbed Kit 6"x8" - 1/2" Plate - 1/8" Socket Top Stick Out



HEAVY-DUTY BALL MOUNTS

HIGH GLOSS POWDER COAT FINISH



Part #	Drop	Shank
BMHD30010	2" Drop	2" x 6" Shank
BMHD30011	2" Drop	2" x 8" Shank
BMHD30012	4" Drop	2" x 6" Shank
BMHD30013	4" Drop	2" x 8" Shank
BMHD30014	6" Drop	2" x 6" Shank
BMHD30210	2" Drop	2.5" x 6" Shank
BMHD30212	4" Drop	2.5" x 6" Shank
BMHD30214	6" Drop	2.5" x 6" Shank

CLASS V 16,000 LB. GTW
1,600 LB. VTW
DO NOT EXCEED VEHICLE TOW RATINGS
LIMITED LIFETIME WARRANTY

HEAVY-DUTY PINTLE PLATE

HIGH GLOSS POWDER COAT FINISH



Part #	Hole	Position	Shank
PMHD14001	6 Hole,	2 Position,	2" x 9" Shank
PMHD14002	8 Hole,	3 Position,	2" x 9" Shank
PMHD14003	8 Hole,	3 Position,	2" x 11" Shank
PMHD14004	14 Hole,	6 Position,	2" x 13" Shank
PMHD14005	14 Hole,	6 Position,	2" x 15" Shank
PMHD14202	8 Hole,	3 Position,	2.5" x 9" Shank

CLASS V 16,000 LB. GTW
1,600 LB. VTW
DO NOT EXCEED VEHICLE TOW RATINGS
LIMITED LIFETIME WARRANTY

TRIPLE TOW BALL MOUNT

HIGH GLOSS POWDER COAT FINISH



CLASS IV 10,000 LB. GTW
1,000 LB. VTW
DO NOT EXCEED VEHICLE TOW RATINGS
LIMITED LIFETIME WARRANTY

BMTT31004	14-0512	Triple Tow Ball Mount
-----------	---------	-----------------------

HEAVY-DUTY RECEIVER HITCH



Three piece no-drill design means quick and easy installation. Shipped in a box to ensure hardware and instructions are included.

Heavy-Duty Receiver Hitch Fit List



CHEVROLET GMC

FORD

DODGE RAM

PART NUMBER	TRUCK YEAR, MAKE, AND MODEL
HDRH25600	2011-2018 Chevrolet/GMC 2500 & 3500 Heavy Duty Long Bed Trucks with factory bumper
HDRH25601	2011-2019 Chevrolet/GMC 2500 & 3500 Heavy Duty Short Bed Trucks with factory bumper
HDRH25189	2001-2010 Chevrolet/GMC 2500 & 3500 Heavy Duty Long Bed Trucks with factory bumper
HDRH25187	2001-2010 Chevrolet/GMC 2500 & 3500 Heavy Duty Long Bed Trucks with 10" step bumper
HDRH25182	2001-2010 Chevrolet/GMC 2500 Heavy Duty Short Bed Trucks with factory bumper
HDRH25217	2008-2018 Chevrolet/GMC 1500 Light Duty Trucks with factory bumper 1999-2007 Chevrolet/GMC 1500 & 2500 Light Duty Trucks with factory bumper
HDRH25122	1988-2009 Chevrolet/GMC Cab & Chassis 34" Frame (Without Dual Tanks) (5 1/2" Drop) 1973-1987 Chevrolet/GMC 1500, 2500, & 3500 Long Bed Trucks with factory bumper
HDRH25198	1988-2009 Chevrolet/GMC Cab & Chassis 34" Frame (8" Drop) 1973-1987 Chevrolet/GMC 1500, 2500, & 3500 Long Bed Trucks with 10" step bumper
HDRH25124	1998-2000 Chevrolet/GMC 1500, 2500, & 3500 Trucks Old Body Style with factory bumper
HDRH25602	2017-2019 Ford F250 & F350 Trucks with factory bumper
HDRH25401	2011-2016 Ford F250 & F350 Trucks with factory bumper
HDRH25230	1999-2010 Ford F250 & F350 Trucks with factory bumper 2008-2010 Ford F450 with factory installed bed and bumper
HDRH25198	1999-2012 Ford Cab & Chassis 34" Frame (8" Drop) 1967-1998 Ford F250 & F350 with 10" step bumper 1967-1996 Ford F150 with 10" step bumper
HDRH25122	1999-2010 Ford Cab & Chassis 34" Frame (5 1/2" Drop) 1967-1998 Ford F250 & F350 Trucks with factory bumper 1967-1996 Ford F150 with factory bumper
HDRH24400	1997-2003 Ford F150 with factory bumper (Rated at 12,000 lbs)
HDRH25500	2014-2018 Ram 2500 & 3500 Short Bed Trucks with factory bumper
HDRH25501	2014-2018 Ram 2500 & 3500 Long Bed Trucks with factory bumper
HDRH25211	2003-2013 Dodge/Ram 2500 & 3500 Trucks with factory bumper 2003-2008 Dodge 1500 Trucks with factory bumper
HDRH25132	1994-2002 Dodge 2500 & 3500 Trucks with factory bumper 1994-2001 Dodge 1500 Trucks with factory bumper
HDRH25122	1972-1993 Dodge 1500, 2500, & 3500 Trucks with factory bumper
HDRH25198	1972-1993 Dodge 1500, 2500, & 3500 Trucks with 10" step bumper

HITCH BALLS

SPECIALTY AND HEAT TREATED



Part #	Ball Diameter	Shank Diameter	Shank Length	Max Load	Rise	Threads Per Inch	Finish
HB94001	2-5/16"	1"	2-1/2"	12K	No Rise	14	Heat Treated
HB94002	2-5/16"	1-1/4"	2-1/2"	24K	1"	12	Heat Treated
HB94003	2-5/16"	1-1/4"	3-1/4"	24K	1"	12	Heat Treated
HB94004	2-5/16"	1-1/4"	2-1/2"	30K	No Rise	12	Heat Treated
HB94005	2-5/16"	1-1/2"	2-3/4"	30K	1"	12	Heat Treated
HB94006	2-5/16"	1-1/2"	2-3/4"	30K	2"	12	Heat Treated
HB94007	2-5/16"	1-3/8"	2-3/4"	30K	1"	12	Heat Treated
HB94008	3"	2"	3-1/4"	30K	No Rise	12	Heat Treated
HB94009	2-5/16"	2"	3-1/2"	30K	No Rise	4.5	Heat Treated
HB94011	2-5/16"	2-3/16"	4"	30K	No Rise	n/a	Heat Treated
HB94050	2-5/16"	1-1/4"	2-1/2"	16K	No Rise	12	Chrome





TOW & STOW® Receiver Hitch

The Tow & Stow is adjustable in height and has multiple ball sizes. By pulling two pins the hitch can be stowed out of the way.

- 21,000 LB. GTW - 2,100 LB. VTW when using the 3" Tow & Stow
- 14,500 LB. GTW - 1,450 LB. VTW when using the 2.5" Tow & Stow
- 10,000 LB. GTW - 1,000 LB. VTW when using the 2" Tow & Stow

	Part Number	Drop	Rise	Ball Size		Part Number	Drop	Rise	Ball Size
BLACK POWDER COATED	TS10033B	3"	3 1/2"	2 5/16" x 2"	CHROME	TS10033C	3"	3 1/2"	2 5/16" x 2"
	TS10035B	3"	3 1/2"	1 7/8" x 2"		TS10047C	3"	3 1/2"	1 7/8" x 2" x 2 5/16"
	TS10047B	3"	3 1/2"	1 7/8" x 2" x 2 5/16"		TS10037C	5"	5 1/2"	2 5/16" x 2"
	TS10037B	5"	5 1/2"	2 5/16" x 2"		TS10048C	5"	5 1/2"	1 7/8" x 2" x 2 5/16"
	TS10038B	5"	5 1/2"	1 7/8" x 2"		TS10040C	7"	7 1/2"	2 5/16" x 2"
	TS10048B	5"	5 1/2"	1 7/8" x 2" x 2 5/16"		TS10049C	7"	7 1/2"	1 7/8" x 2" x 2 5/16"
	TS10040B	7"	7 1/2"	2 5/16" x 2"		TS20037C	5"	4 1/2"	2 5/16" x 2"
	TS10049B	7"	7 1/2"	1 7/8" x 2" x 2 5/16"		TS20048C	5"	4 1/2"	1 7/8" x 2" x 2 5/16"
	TS10043B	9"	9 1/2"	2 5/16" x 2"		TS20040C	7"	7 1/2"	2 5/16" x 2"
	TS10050B	9"	9 1/2"	1 7/8" x 2" x 2 5/16"		TS20049C	7"	7 1/2"	1 7/8" x 2" x 2 5/16"
2.5" SHANK	TS20037B	5"	4 1/2"	2 5/16" x 2"	2.5" CHROME	TS10033BB	3"	3 1/2"	2 5/16" x 2"
	TS20048B	5"	4 1/2"	1 7/8" x 2" x 2 5/16"		TS10047BB	3"	3 1/2"	1 7/8" x 2" x 2 5/16"
	TS20040B	7"	7 1/2"	2 5/16" x 2"		TS10037BB	5"	5 1/2"	2 5/16" x 2"
	TS20049B	7"	7 1/2"	1 7/8" x 2" x 2 5/16"		TS10048BB	5"	5 1/2"	1 7/8" x 2" x 2 5/16"
3" SHANK	TS30037B	5"	4 1/2"	2 5/16" x 2"	BROWNING	TS10055	8 1/2"	4 1/2"	2" Shank with 2" Ball
	TS30048B	5"	4 1/2"	1 7/8" x 2" x 2 5/16"		TS10056	8 1/2"	4 1/2"	2" Shank with 2 5/16" Ball
	TS30040B	7"	7 1/2"	2 5/16" x 2"		TS20055	8 1/2"	4 1/2"	2.5" Shank with 2" Ball
	TS30049B	7"	7 1/2"	1 7/8" x 2" x 2 5/16"		TS20056	8 1/2"	4 1/2"	2.5" Shank with 2 5/16" Ball
					PINTLE				





INNOVATION LEADER IN BRAKE CONTROLLERS

Spectrum shown

Echo®

Bluetooth connection to control all brake settings from your smartphone



Mobile

NEW

Under-dash

Spectrum™

Controls all brake settings with a simple push-button rotary knob



Assure™

Large, high-quality OLED screen displays concise, easy-to-read messages



Triflex™

Triple-axis, motion-sensing accelerometer for highly responsive, smooth stops



Discovery™

Adjustable power and ramp time with no internal moving parts and no leveling



Venturer™

LED indicator lengthens as power is applied



Scan to learn more!

Echo mobile shown





Scan to learn more



BRAKE CONTROLLERS



Echo® brake controllers

- Bluetooth connection to control all brake settings from your smartphone
- Custom-designed app monitors brake activity and sends status updates
- Triple-axis, motion-sensing accelerometer for highly responsive, smooth stops
- Automatic calibration reduces setup requirements
- Incoming calls can be received while app is running
- Built-in reverse-polarity and short-circuit protection
- Compatible with low-volt, PWM, ABS, cruise control and electric over hydraulic
- Compatible with Echo manual override button #51189 (sold separately) for hands-free driving



Echo mobile

- Wireless, portable design allows for easy transfer from one vehicle to another
- Zero-tool, plug-and-play install between vehicle-trailer 7-way connectors
- Stores multiple user and vehicle-trailer profiles
- Multi-color LED indicates power, trailer detection and wireless connectivity
- Potted circuit board is sealed off from the elements for lasting durability
- Retention strap and locking tab help keep Echo firmly installed into 7-way



NEW

Visit curtmfg.com for harness applications

Echo under-dash

- Stores multiple trailer profiles
- Multi-color LED indicator for easy setup and troubleshooting
- Clear, in-app warning system for voltage recognition and no-brake situations
- Sleep mode feature to reduce power drain
- Simple installation using adhesive or screws
- Plug-and-play install with vehicle-specific quick plug harness (sold separately)



DASH INTEGRATION FOR OE LOOK AND FEEL

Spectrum™ brake controller

- Triple-axis, motion-sensing accelerometer for highly responsive, smooth stops
- Easily accessible manual override with the press of a button
- Features two installation options: drill mount or surface adhesive mount
- User-selectable power output and trailer brake light activation
- Automatic leveling and calibration eliminate setup requirements
- Equipped with a quick plug for easy, plug-and-play installation
- Operates 2-8 trailer brakes at a time (1-4 axles)
- Built-in reverse-polarity and short-circuit protection
- Compatible with low-volt, PWM, ABS, cruise control and electric over hydraulic
- Tow vehicle 'low voltage' and trailer disconnect indicators
- Includes mounting hardware

Visit curtmfg.com for harness applications



1-7/8" diameter

51170 interface actual size (1-7/8")



51170 all components



Controls all brake settings with a simple push-button rotary knob



Clean, dash-mounted, OEM-style user interface with 10 tri-color LEDs



Main module can be mounted out of sight to maintain a consistent, original equipment look



5TH WHEEL HITCHES

PowerRide™

- Tough, professional-grade capacity and enhanced functionality
- Constructed with a cast steel main body for dependable strength
- Tested and rated to 30,000 lbs. GTW / 7,500 lbs. vertical load per SAE J2638
- Patented interlocking jaws for full kingpin contact and coupling security
- Premium, textured, dark grey teridium finish for lasting rust resistance
- Compatible with kingpin extension boxes, including common pivoting pin boxes (wedge required)
- 6" height adjustment for greater versatility versus 3" options
- No welding or fabrication required
- Patent# 8,827,298



16320 - head with legs

Operational Features



Ergonomic, self-resetting handle for easier use from the side of the truck bed



Multi-directional, cast yoke head for a smooth ride and less strain on the truck



Three-position coupling indicator clearly shows coupling status

Design Features



Strategic grip points for ergonomic moving and handling



Integrated polyethylene plates for smooth operation, reduced wear and no grease



Fast, one-pin head removal makes moving easy with smaller, lighter pieces



5TH WHEEL HITCHES

A-Series™

- Available in 16K, 20K, 25K and 30K capacities
- Extra wide head opening for easier coupling
- Cast yoke and poly-torsion inserts suppress shock loads and reduce noise
- Constructed with a cast steel main body for a more precise build (A25 and A30 only)
- Offers three height adjustment positions to adapt to each unique truck bed
- Compatible with kingpin extension boxes, including common pivoting pin boxes (wedge #16992 required)
- Includes a polyethylene lube plate to eliminate messy grease deposits
- Durable carbide black powder coat finish
- Tested for safety in accordance with SAE J2638
- Patent# 8,827,298



16190

Operational Features



Lockable handle self-resets to the ready-to-couple position after the hitch is uncoupled



Fully articulating torsion head for controlled coupling and stable towing



Three-position coupling indicator clearly shows coupling status

Design Features

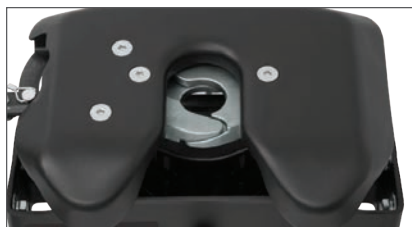

High-strength, interlocking jaws fully wrap the kingpin to minimize noise



Alignment pegs and accessible mounting bolts for simple leg-to-body attachment (excl A16)



Fast, one-pin head removal makes moving easy with smaller, lighter pieces





5TH WHEEL HITCHES

E-Series™

- Pivots on dual axes for 10° of lateral movement
- Automatically locks for easy, secure coupling
- Operates using a single handle with few moving parts
- Features an anti-rattle skid plate to help reduce noise
- Offers four height adjustment positions to adapt to each unique truck bed
- Compatible with kingpin extension boxes, including common pivoting pin boxes (wedge #16991 required)
- Durable carbide black powder coat finish
- Tested for safety in accordance with SAE J2638



16115



Pivots on dual axes for 10° of lateral movement



Features an anti-rattle skid plate to help reduce noise



Single-handle operation with auto-lock for easy, secure coupling

Puck system mounting

- Allows CURT 5th wheel hitches to fit an OEM puck system
- Quarter-turn anchors allow for quick installation and removal
- Anchors can be adjusted to eliminate chucking between the legs or roller and the puck system
- Tested for safety in accordance with SAE J2638
- Highly durable carbide black or teridium grey powder coat finish
- Capacity limited to lowest-rated towing component

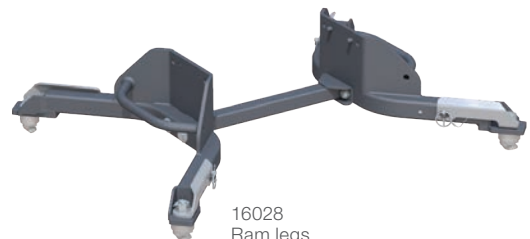

16028
Ram legs



5TH WHEEL HITCHES

OEM puck system base rail adapters

- Convert the truck's puck system to industry-standard 5th wheel base rails
- No hitch leg reconfiguring or disassembly required



Easily transfer existing hitch from previous truck to new puck-equipped truck



Industry-standard rails accept most 5th wheel legs and rollers



16027 base rail adapter shown with A20 head and R20 roller (not included)

Make / Model	Style	Years	GTW	Adds Height	Part #
Chevrolet / GMC					
Silverado / Sierra 2500 HD / 3500 HD	With 5th wheel prep package	20 - 22	25,000 lbs.	2-1/4"	16027
		16 - 19	25,000 lbs.	2-1/4"	16050 NEW
Ford					
F-250 / F-350 Super Duty	With 5th wheel prep package	11 - 22	25,000 lbs.	2-1/4"	16027
Ram					
2500 / 3500	With 5th wheel prep package	13 - 21	25,000 lbs.	2-3/4"	16042 NEW

OEM puck system 5th wheel hitch legs & roller products

Visit curtmfg.com for applications



16030 Chev / GMC legs



16020 Ford roller system



16023 Chev / GMC roller adapter





5TH WHEEL HITCHES

R-Series™ rollers

- Provides 12" of travel while most competitive models only offer 10"
- Mounts to all industry-standard base rails
- Tested for safety in accordance with SAE J2638
- Durable carbide black powder coat finish



16550

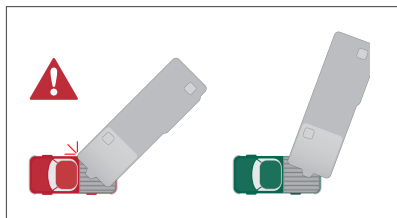

Allows for forward and rearward movement of 5th wheel hitch for added clearance



Constructed with solid, non-binding rods that lock the hitch into position



Uses wheels to bear the weight, instead of hollow rods like competition

Part #	GTW	Roller Series	For Use With	Finish
16560	16,000 lbs.	R16	A16 (16520) and E16 (16515)	Carbide black
16550	20,000 lbs.	R20	A20 (16540) and Q20 (16530)	Carbide black
16570	24,000 lbs.	R24	Q24 (16545)	Carbide black

Custom under-bed brackets

- Designed to be used in combination with CURT base rails (see application guide for part numbers)
- Vehicle-specific applications reduce or eliminate drilling, cutting installation time in half
- Protected by a rust-resistant liquid A-coat
- Includes mounting hardware



Brackets shown with 16204 base rails

Base rails

- Capacities limited to the lowest rated component
- Industry-exclusive 40K option
- Compatible with CURT and most competitive 5th wheel hitches, rollers and gooseneck adapters
- All universal brackets require drilling or welding
- Tested according to SAE J2638 specifications



16200



Visit curtmfg.com
for applications

TOWING ELECTRICAL

Custom wiring harness extensions

- Routes a 7-way RV blade socket into truck bed while retaining use of rear socket
- No cutting or splicing
- Allows for easy connection of 5th wheel or gooseneck wiring
- Spring-loaded dust cover
- Requires 2-1/8" hole saw for installation



56071 (7') / 56001 (10')



56070 (7') / 56000 (10')

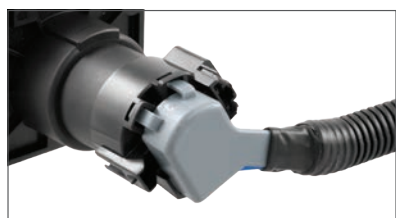

Right-angle plug for easy installation



7' routes socket into rear of the truck bed



10' routes socket closer to truck cab

Taillight converters

For vehicles that are not compatible with CURT custom wiring options, a taillight converter provides a reliable alternative. CURT taillight converters splice into the vehicle's wiring system and provide a standard 4-way flat trailer connector. **Use the application guide on curtmfg.com to find the right wiring solution.**

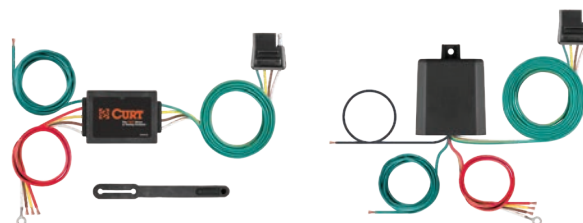

Protective MultiPro™ / Multi-flex™ Tailgate Sensors

- Prevents deployment of inner tailgate panel when ball mount is installed
- Helps avoid costly tailgate damage
- Compatible with GMC MultiPro and Chevrolet Multi-Flex tailgates
- Easy installation requires no wire cutting or splicing
- No extra electronic components or batteries required
- Sleek, durable design suited for all work conditions
- Does not interfere with trailer or towing accessories



58265 (2") / 58266 (2-1/2")





Scan to learn more



FLAT TOWING

Rambler™ tow bar

- Full articulating head and shackles to prevent binding on the roughest terrain
- Rigorous physical testing for proven safety and performance
- Polymer isolator washers reduce friction for smooth, anti-rattle operation
- Compatible with CURT or Blue Ox® base plates (sold separately)

Part #	Shank Size	GTVW
70001	2"	7,500 lbs.



Non-binding latches



Patent-pending, non-binding latches for easy release on uneven ground

Three stowing positions



Three stowing positions to avoid obstructions and maximize versatility

Only 40 lbs.



With a total weight of only 40 pounds, Rambler is easy to lift, carry and install

Custom-fit tow bar base plates

- Spreads towing forces equally for reduced stress on the vehicle frame
- Made with a vehicle-specific design for a custom fit
- Precisely welded for superior strength and fit
- Physically tested to gross vehicle weight rating (GVWR)
- Co-cured in a rust-resistant liquid A-coat with a gloss black powder coat finish (zinc-plated attachment tabs)



See next page or visit curtmfg.com for applications



Scan to learn more



WEIGHT DISTRIBUTION

TruTrack™ 4P weight distribution hitches

- Four points of sway control work together to keep trailer aligned
- Integrated sway control actively resists sway and levels the vehicle and trailer
- Welded head with cast pieces and trunnion-style forged steel spring bars
- Uses spring & cam system with hardened components, instead of metal friction alone
- Brackets use friction to resist lateral movement, replacing a sway control
- Durable carbide black powder coat finish, black-oxide plated cams and stainless steel balls



17500

Part #	GTW	Description
17499	5,000 - 8,000 lbs.	WD hitch only (no trailer ball)
17500	8,000 - 10,000 lbs.	WD hitch, pre-torqued trailer ball
17501	10,000 - 15,000 lbs.	WD hitch, pre-torqued trailer ball

Did you know?

TruTrack is designed to work in two neutral spring bar settings to fit almost all A-frame trailers. The spring bars can be positioned in the 30- or 70-degree position (+/-5 degrees). Adjustment takes only 15 to 20 minutes, start to finish.



Quick, easy tilt adjustment, no disassembly (excl 17501)



Adjustable brackets and lift handle provide fixed support

How active sway control works

Bearings within the head maintain pressure on the spring bars, actively aligning the trailer with the vehicle.

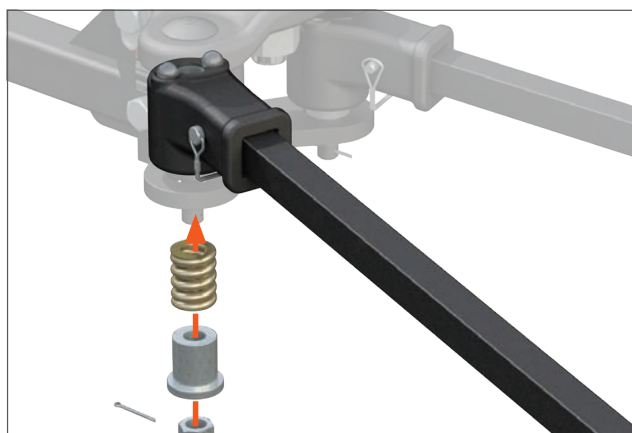

Lateral forces compress the bearings into a rotational groove to actively resist sway. More sway = greater resistance.



Upward force on the ends of the spring bars pushes the bearings into the 'home' location, increasing sway control.



When turning, the bearings compress to their critical limit, freeing them to make a smooth turn.





INTEGRATED SWAY CONTROL FOR SMOOTHER TOWING

TruTrack™ 2P weight distribution hitch

- Up to 10,000 lbs. GTW / 1,000 lbs. TW
- Weight ratings are limited to vehicle manufacturer's stated capacities
- Two points of sway control use friction to keep trailer aligned
- Integrated sway control reduces sway and levels the vehicle and trailer
- Heavy-duty, fabricated head with round, forged steel spring bars
- 7-hole, 2" shank can be flipped for maximum adjustability (#17601 only)
- Durable carbide powder coat finish

NEW



Two points of sway control use friction to keep trailer aligned



Head tilt adjustment feature simplifies setup and eliminates the need for washers



Adjustable brackets provide fixed support unlike spring bar chain models

Part #	GTW	TW	Description
17600	8,000 - 10,000 lbs.	800 - 1,000 lbs.	Hitch head, spring bars and lift brackets (trailer ball not included)
17601	8,000 - 10,000 lbs.	800 - 1,000 lbs.	Hitch head, shank, trailer ball, spring bars and lift brackets



WEIGHT DISTRIBUTION

Trunnion bar kits & WD hitches

- Up to 15,000 lbs. GTW / 1,500 lbs. TW
- Heavy-duty, formed head with trunnion, forged steel spring bars
- Features built-in sway control attachment tabs
- 2" shank can be flipped to provide necessary drop or rise (see page 180 for shank options)
- Hookup brackets and lift handle allow for easy leveraging of spring bars
- Durable carbide black powder coat finish



Kit #	Hitch #	GTW	TW	Kit Includes
--	17300*	5,000 - 6,000 lbs.	500 - 600 lbs.	--
--	17302	8,000 - 10,000 lbs.	800 - 1,000 lbs.	--
17322	17332	8,000 - 10,000 lbs.	800 - 1,000 lbs.	Sway control, pre-torqued trailer ball, chains pre-assembled to spring bars
17422	17333	10,000 - 15,000 lbs.	1,000 - 1,500 lbs.	Sway control, pre-torqued trailer ball, chains pre-assembled to spring bars

* Continued while supplies last

Round bar kits & WD hitches

- Up to 14,000 lbs. GTW / 1,400 lbs. TW
- Grease zerk fitting provides easy, continuous lubrication
- Heavy-duty, fabricated head with round, forged steel spring bars
- Features built-in sway control attachment tabs
- 2" shank can be flipped to provide necessary drop or rise
- Hookup brackets and lift handle allow for easy leveraging of spring bars
- Durable carbide black powder coat finish



Kit #	Hitch #	GTW	TW	Kit Includes
--	17050	5,000 - 6,000 lbs.	500 - 600 lbs.	--
--	17051	6,000 - 8,000 lbs.	600 - 800 lbs.	--
17062	17052	8,000 - 10,000 lbs.	800 - 1,000 lbs.	Sway control, pre-torqued trailer ball, chains pre-assembled to spring bars
17063	17057	10,000 - 14,000 lbs.	1,000 - 1,400 lbs.	Sway control, pre-torqued trailer ball, chains pre-assembled to spring bars



SIX ROBBLEES EXCLUSIVE HITCH & SWAY CONTROL KIT

2 MV ROUND BAR WD HITCHES & KITS

- Up to 12,000 lbs. GTW / 1,200 lbs. TW
- Weight ratings are limited to vehicle manufacturer's stated capacities
- Grease zerk fitting provides easy, continuous lubrication
- Equipped with round, forged steel spring bars for reliable strength
- Heavy-duty, fabricated head can be adjusted for precise leveling
- Features built-in sway control attachment tabs
- 2" shank can be flipped to provide necessary drop or rise
- Snap-up brackets and lift handle allow for easy leveraging of spring bars
- Highly durable carbide powder coat finish



Easily-access grease zerk fittings



Pkg#	GTW	TW	Bars	Description
MV Round Bar Weight Distribution Kits				
17065	10,000 - 12,000 lbs.	1,000 - 1,200 lbs.	31-3/16"	WD hitch (17057), sway control (17200), pre-torqued 2-5/16" trailer ball (40030) and chains pre-assembled to spring bars



SWAY CONTROL & REPLACEMENT PARTS

Sway control units reduce lateral movement, commonly caused by the wind, while pulling a trailer. The diagrams below illustrate the effectiveness of using sway control units. Two sway control units should be used for maximum control and stability.

Pkg#	Description
17203	Kit includes: - Sway control unit - Trailer-mounted attachment ball and bolts (17201) - Hitch-mounted attachment ball (40093) - Weld-on tab (45822) - Mount reinforcement plate and spring clips



45820 with 40093 ball (sold separately)



45822



17201



40093





WEIGHT DISTRIBUTION

Weight distribution shanks

- Up to 15,000 lbs. GTW / 1,500 lbs. TW
- Provides an adjustable mount for most weight distribution hitches
- Multiple holes for adjustable head height
- Can be flipped to provide necessary drop or rise (select models)
- 3/4" holes are spaced 1-1/4" from center to center
- Constructed from solid steel for reliable strength
- Protected by a durable black powder coat finish
- Limited to spring bar capacity



Sway control kit

Sway control reduces lateral movement while pulling a trailer. The diagrams below illustrate the effectiveness of using sway control units. Two sway control kits should be used for maximum control and stability.

Part #	Includes
17200	Sway control unit
	Trailer attachment ball, plate and eight bolts
	Hitch-mounted attachment ball (40093)
	Weld-on tab (45822)
	Mount reinforcement plate
	Spring clips, qty 2



Hookup brackets

- Allows for repositioning of spring bars around an LP tank or other obstruction
- Replaces factory spring bar brackets or hangers
- Durable carbide powder coat finish

Part #	Description
17003	Clamp-on chain hangers
17005	Bolt-on chain hangers





TOWING ACCESSORIES

RV towing starter kit

- Complete kit to maximize comfort and control when towing a small travel trailer
- Ideal for vehicles less than 5,000 lbs. GVW and trailers 3,500 to 5,000 lbs. GTW
- Pre-torqued RockerBall dampens jerking and jarring for smoother towing,
- Echo® brake controller uses Bluetooth and smartphone to control trailer brakes,
- Sway control unit helps limit lateral trailer movement to reduce sway



Part #	Shank	GTW / TW	Ball	Drop	Length	Included Parts
45190	2"	7,500 / 750 lbs.	2-5/16"	1"	7-1/2"	45149 RockerBall pre-torqued on sway tab mount, 51180 Echo brake controller, 17200 sway control, 22323 anti-rattle

RockerBall™ cushion hitch with sway tab

- Dynamic trailer ball and ball mount kit featuring ShockDrop™ technology
- Pre-torqued RockerBall dampens jerking and jarring for smoother towing
- Reduces shock loads to the vehicle during sudden braking or acceleration
- Sway tab provides an attachment point for a trailer sway control unit

NEW



45149

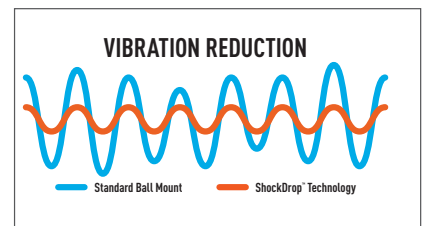

Unlike a traditional metal-on-metal towing connection, ShockDrop absorbs unevenness in the road to maximize comfort

Part #	Shank Size	GTW / TW	Ball Diameter	Drop	Length
45149	2"	7,500 / 750 lbs.	2-5/16"	1"	7-1/2"

Safety chain holder brackets

- Maintains proper safety chain function for trailer disconnect
- Ensure proper shank clearance between receiver collar and accessory (see table)

NEW



45807



45806

Part #	Fits	Style	Required Clearance	Finish
45806	2" shanks	Bolt-on	5/8"	Zinc-plated
45807	2" shanks	Clip-on	1/4"	Stainless steel



Provides intermediate hangers to keep chains off the ground



Scan to learn more



SHOCKDROP™ TECHNOLOGY PRODUCTS

Upgrade your towing experience

- Dampens jerking and jarring from bumps and potholes for smoother towing
- Cushioned isolator reduces rattling and vibration for a more comfortable ride
- Improved trailer control during events of sudden braking
- Minimizes stress on tow vehicle's brakes and suspension for extended longevity
- Virtually maintenance-free with no airbag or bearings to service



Enhanced comfort.

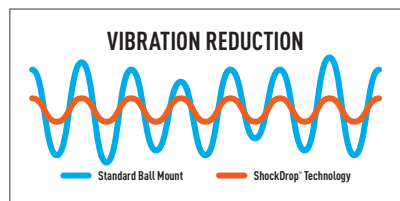

Unlike a traditional metal-on-metal towing connection, ShockDrop absorbs unevenness in the road to maximize comfort

Improved control.

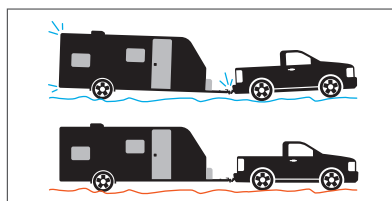

ShockDrop dynamically reacts to jarring, limiting its effects and giving the driver increased control on the road

Unmatched confidence.



Unlike a cushion hitch with an airbag or bearings, ShockDrop is virtually maintenance-free and is tested for 300K+ cycles

Rebellion™ XD cushion hitches

- Dynamic, adaptive suspension ball mount with ShockDrop technology
- Lighter weight for less stress on the trailer hitch
- Adjustable head for precise leveling
- Available in capacities up to 20,000 lbs.
- Cast steel with a textured, dark grey teridium finish

RockerBall™ trailer balls

- Dynamic trailer ball featuring ShockDrop technology
- Anti-swivel base compatible with most standard ball mounts
- Also available in towing starter kits including a ball mount, RockerBall and anti-rattle hitch pin
- Not compatible with Rebellion™ XD ball mount

Part #	Shank	Includes	Ball	GTW
45949	2"	Shank, tongue (no ball)	--	15,000 lbs
45981	2"	Shank, tongue, trailer ball	2"	10,000 lbs
45980	2"	Shank, tongue, trailer ball	2-5/16"	15,000 lbs
45951	2"	Shank and dual-ball	2"	10,000 lbs
			2-5/16"	15,000 lbs
45955	2-1/2"	Shank and dual-ball	2"	10,000 lbs
			2-5/16"	20,000 lbs

Shank Diameter	Shank Length	Rise	Tongue Width	GTW	Part #
2" Ball Diameter					
3/4"	2-1/8"	1-1/2"	2"	3,500 lbs.	40246
1"	2-1/8"	1-1/2"	2-1/2"	7,500 lbs.	40247
2-5/16" Ball Diameter					
1"	2-1/2"	1-5/8"	2-1/2"	7,500 lbs.	40248
1-1/4"	2-7/8"	1-5/8"	3"	12,000 lbs.	40249





Class 1 & 2 ball mounts

- Fits any 1-1/4" x 1-1/4" receiver tube opening
- Multiple drop and rise options to accommodate various vehicle-trailer combinations
- Compatible with anti-rattle to help stop vibration



Part #	GTW / TW	Drop	Rise	Length	Tongue Hole Size	Shank Type	Finish
Class 1 Ball Mounts							
45018	2,000 / 200 lbs.	1-1/4"	5/8"	6-3/4"	3/4"	Hollow	Gloss black
45019	2,000 / 200 lbs.	1-1/4"	5/8"	9-3/4"	3/4"	Hollow	Gloss black
45027	2,000 / 200 lbs.	3-1/4"	2-5/8"	6-1/4"	3/4"	Hollow	Gloss black
45022	2,000 / 200 lbs.	3-1/4"	2-5/8"	7-1/4"	3/4"	Hollow	Gloss black
45026	2,000 / 200 lbs.	3-1/4"	2-5/8"	9-3/8"	3/4"	Hollow	Gloss black
45028	2,000 / 200 lbs.	6"	4-5/8"	5-9/16"	3/4"	Solid	Gloss black
45021	2,000 / 200 lbs.	--	3-3/4"	9-1/2"	3/4"	Solid	Gloss black
45023	2,000 / 200 lbs.	--	3-3/4"	11-1/2"	3/4"	Solid	Gloss black
45024	2,000 / 200 lbs.	--	5"	9-9/16"	3/4"	Solid	Gloss black
45025	2,000 / 200 lbs.	--	5"	11-9/16"	3/4"	Solid	Gloss black
Class 2 Ball Mounts							
45503	3,500 / 350 lbs.	1"	3/8"	7-13/16"	3/4"	Solid	Gloss black
45518	3,500 / 350 lbs.	1-1/4"	3/4"	6-3/4"	3/4"	Solid	Gloss black
45519	3,500 / 350 lbs.	1-1/4"	3/4"	9-3/4"	3/4"	Solid	Gloss black
45017	3,500 / 350 lbs.	3-1/4"	2-5/8"	6-1/4"	3/4"	Solid	Gloss black
45521	3,500 / 350 lbs.	3-1/4"	2-5/8"	7-1/4"	3/4"	Solid	Gloss black
45016	3,500 / 350 lbs.	3-1/4"	2-5/8"	9-3/8"	3/4"	Solid	Gloss black
45520	3,500 / 350 lbs.	--	3-1/8"	9-3/4"	3/4"	Solid	Gloss black
45510	3,500 / 350 lbs.	--	3-1/8"	10-5/16"	3/4"	Solid	Gloss black
45522	3,500 / 350 lbs.	--	3-1/8"	11-1/4"	3/4"	Solid	Gloss black
45000	3,500 / 350 lbs.	--	3-7/8"	13-1/2"	3/4"	Solid	Gloss black
45014	3,500 / 350 lbs.	--	5"	9-5/8"	3/4"	Solid	Gloss black
45015	3,500 / 350 lbs.	--	5"	11-5/8"	3/4"	Solid	Gloss black





Class 3 ball mounts

- Fits any 2" x 2" receiver tube opening
- Multiple drop and rise options to accommodate various vehicle-trailer combinations
- Increased drop on select models allows for level towing with lifted vehicles
- Compatible with anti-rattle to help stop vibration
- White box kits include a pin & clip



Black Bulk #	Chrome Bulk #	White Box Kit #	With Pin & Clip Poly Bag #	GTW / TW	Drop	Rise	Length	Tongue Hole Size	Shank Type
45030	45290	45032	45033	7,500 / 750 lbs.	2"	3/4"	7-1/2"	1"	Hollow
45010	--	45012	--	7,500 / 750 lbs.	2"	3/4"	8-1/4"	1"	Hollow
45040	--	--	--	7,500 / 750 lbs.	2"	3/4"	10-1/4"	1"	Hollow
45020	--	--	--	7,500 / 750 lbs.	2"	3/4"	10-1/4"	1"	Hollow
45260	--	--	--	7,500 / 750 lbs.	2"	3/4"	12-1/4"	1"	Hollow
45250	--	--	--	7,500 / 750 lbs.	2"	3/4"	12-1/4"	1"	Hollow
45050	45296	45052	--	7,500 / 750 lbs.	4"	2"	8-1/4"	1"	Hollow
45060	--	--	--	7,500 / 750 lbs.	4"	2"	10-1/4"	1"	Hollow
45270	--	--	--	7,500 / 750 lbs.	4"	2"	13"	1"	Hollow
45070	45297	--	--	7,500 / 750 lbs. drop 6,000 / 600 lbs. rise	6"	4"	9-1/4"	1"	Hollow
45080	--	--	--	7,500 / 750 lbs. drop 6,000 / 600 lbs. rise	6"	4"	12-1/4"	1"	Hollow
45280	--	--	--	7,500 / 750 lbs. drop 6,000 / 600 lbs. rise	6"	4"	14-1/4"	1"	Hollow
45090	--	--	--	5,000 / 500 lbs. drop 3,500 / 350 lbs. rise	8"	6"	11-1/2"	1"	Hollow
45100	--	--	--	5,000 / 500 lbs. drop 3,500 / 350 lbs. rise	8"	6"	13"	1"	Hollow
45110	--	--	--	5,000 / 500 lbs. drop 3,500 / 350 lbs. rise	10"	8"	13"	1"	Hollow
45112	--	--	--	5,000 / 500 lbs. drop 3,500 / 350 lbs. rise	10"	8"	14"	1"	Hollow





Loaded ball mounts

- Includes a factory-torqued trailer ball (pin & clip included on select models)
- Three-packs include an informative point-of-purchase tray



Part #	Box #	Three-Pack #	GTW / TW	Ball Diameter	Drop	Length	Shank Type	Finish
1-1/4" x 1-1/4" Loaded Ball Mounts								
45148*	--	--	3,500 / 350 lbs.	2"	3-1/4"	7-1/4"	Solid	Gloss black
45147*	--	--	3,500 / 350 lbs.	2"	1-1/4"	9-3/4"	Solid	Gloss black
2" x 2" Loaded Ball Mounts								
45034*	--	--	3,500 / 350 lbs.	1-7/8" (40002)	2"	8-1/4"	Hollow	Gloss black
--	45293*	--	3,500 / 350 lbs.	1-7/8" (40002)	2"	8-1/4"	Hollow	Chrome-plated
45036*	--	45037*	7,500 / 750 lbs.	2" (40037)	2"	8-1/4"	Hollow	Gloss black
--	45295*	--	7,500 / 750 lbs.	2" (40037)	2"	8-1/4"	Hollow	Chrome-plated
45041*	--	--	7,500 / 750 lbs.	2-5/16" (40005)	2"	8-1/4"	Hollow	Gloss black
45055*	--	--	3,500 / 350 lbs.	1-7/8" (40002)	4"	8-1/4"	Hollow	Gloss black
45056*	--	45057*	7,500 / 750 lbs.	2" (40037)	4"	8-1/4"	Hollow	Gloss black
45042*	--	--	7,500 / 750 lbs.	2-5/16" (40005)	4"	8-1/4"	Hollow	Gloss black
45064*	--	--	7,500 / 750 lbs.	2" (40037)	6"	9-1/4"	Hollow	Gloss black
45065*	--	--	7,500 / 750 lbs.	2-5/16" (40005)	6"	9-1/4"	Hollow	Gloss black
2" x 2" Loaded Ball Mounts - Forged								
45331*	--	--	15,000 / 1,500 lbs.	2-5/16" (40030)	2"	8-1/2"	Solid	Carbide black
45332*	--	--	15,000 / 1,500 lbs.	2-5/16" (40030)	4"	8-1/2"	Solid	Carbide black
45370	--	--	15,000 / 1,500 lbs.	2-5/16" (40030)	6"	9-1/2"	Solid	Carbide black
2-1/2" x 2-1/2" Loaded Ball Mounts - Forged								
45371	--	--	20,000 / 2,000 lbs.	2-5/16" (40008)	2"	8-1/2"	Solid	Carbide black
45372	--	--	20,000 / 2,000 lbs.	2-5/16" (40008)	4"	8-1/2"	Solid	Carbide black
45373	--	--	20,000 / 2,000 lbs.	2-5/16" (40008)	6"	9"	Solid	Carbide black
45374	--	--	20,000 / 2,000 lbs.	2-5/16" (40008)	8"	10"	Solid	Carbide black
3" x 3" Loaded Ball Mounts - Forged								
45375	--	--	20,000 / 2,000 lbs.	2-5/16" (40008)	4"	9"	Solid	Carbide black
45376	--	--	20,000 / 2,000 lbs.	2-5/16" (40008)	6"	10"	Solid	Carbide black
45377	--	--	20,000 / 2,000 lbs.	2-5/16" (40008)	8"	10-1/2"	Solid	Carbide black

* Includes pin & clip





Aluminum ball mounts

NEW

- Fits trailer hitches with a 2" x 2" receiver tube opening
- Constructed from solid aluminum to be lightweight and naturally rust-resistant



Constructed from solid aluminum to be lightweight and naturally rust-resistant

Part #	GTW / TW	Drop	Rise	Length	Tongue Hole Size	Shank Type	Finish
45360	8,000 / 800 lbs.	2"	1"	8-1/2"	1"	Solid	Aluminum
45361	8,000 / 800 lbs.	4"	3"	8-1/2"	1"	Solid	Aluminum
45362	8,000 / 800 lbs.	6"	5"	8-1/2"	1"	Solid	Aluminum

Towing starter kits

RockerBall™ starter kits

- Dynamic trailer ball and ball mount kit featuring ShockDrop™ technology
- Dampens jerking and jarring from bumps and potholes for smoother towing
- Includes anti-rattle kit to help stop rattling and vibration

Scan to learn more



Part #	Shank Size	GTW / TW	Ball Diam.	Drop	Length	Included Parts
RockerBall Starter Kits						
45143	2"	7,500 / 750 lbs.	2"	3"	8-1/4"	45050 ball mount, 40047 RockerBall, 22321 anti-rattle
45144	2"	7,500 / 750 lbs.	2"	5"	9-1/4"	45070 ball mount, 40047 RockerBall, 22321 anti-rattle
Standard Starter Kits						
45534	2"	7,500 / 750 lbs.	2"	2"	8-1/4"	Ball mount, trailer ball, hitch lock, hitch tube cover, pin & clip, case
45554	2"	7,500 / 750 lbs.	2"	4"	8-1/4"	Ball mount, trailer ball, hitch lock, hitch tube cover, pin & clip, case





Fusion™ ball mounts

- Fits any 2" x 2" receiver tube opening
- Welded trailer ball cannot be loosened or stolen
- Compatible with anti-rattle to help stop vibration



45141 (2" ball) - includes hitch lock

45131 (1-7/8" ball)
45134 (2" ball)

45142 (2" ball) - includes hitch lock

45151 (1-7/8" ball)
45154 (2" ball)

45152 (1-7/8" ball)
45155 (2" ball)

Part #	GTW / TW	Ball Diameter	Drop	Rise	Length	Finish	Includes
45131	5,000 / 500 lbs.	1-7/8"	2"	--	7-1/2"	Gloss black	Pin & clip
45134	7,500 / 750 lbs.	2"	2"	--	7-1/2"	Gloss black	Pin & clip
45141	7,500 / 750 lbs.	2"	2"	--	7-1/2"	Gloss black	Hitch lock
45151	5,000 / 500 lbs.	1-7/8"	4"	--	8-1/8"	Gloss black	Pin & clip
45154	7,500 / 750 lbs.	2"	4"	--	8-1/8"	Gloss black	Pin & clip
45142	7,500 / 750 lbs.	2"	4"	--	8-1/8"	Gloss black	Hitch lock
45152	5,000 / 500 lbs.	1-7/8"	--	2"	8-1/8"	Gloss black	Pin & clip
45155	7,500 / 750 lbs.	2"	--	2"	8-1/8"	Gloss black	Pin & clip

Class 4 ball mounts

- Fits any 2" x 2" receiver tube opening
- Increased drop allows for level towing with lifted vehicles
- Compatible with anti-rattle to help stop vibration



45310

45311

45336

Part #	GTW / TW	Drop	Rise	Length	Tongue Hole Size	Shank Type	Finish
45310	10,000 / 1,000 lbs.	2"	1"	9-3/8"	1-1/4"	Hollow	Gloss black
45311	10,000 / 1,000 lbs.	4"	2-3/4"	9-3/8"	1-1/4"	Hollow	Gloss black
45336	10,000 / 1,000 lbs.	6"	4-3/4"	9-3/8"	1-1/4"	Hollow	Gloss black
45338	10,000 / 1,000 lbs.	8"	6-3/4"	9-3/8"	1-1/4"	Hollow	Gloss black
45312	12,000 / 1,200 lbs.	2"	1"	9-3/8"	1-1/4"	Solid	Gloss black
45313	12,000 / 1,200 lbs.	4"	3"	9-3/8"	1-1/4"	Solid	Gloss black
45446	12,000 / 1,200 lbs.	6"	5"	9-3/8"	1-1/4"	Solid	Gloss black
45448	12,000 / 1,200 lbs.	8"	7"	9-3/8"	1-1/4"	Solid	Gloss black



45338





Dual-length ball mounts

- Fits any 2" x 2" receiver tube opening
- Two hitch pin holes for varying length
- Compatible with anti-rattle to help stop vibration



Part #	GTW / TW	Drop	Rise	Length	Hole	Finish
45220	7,500 / 750 lbs.	2"	3/4"	7-1/2" or 10-1/2"	1"	Gloss black
45230	7,500 / 750 lbs.	4"	2"	8-1/8" or 11-1/8"	1"	Gloss black
45240	7,500 / 750 lbs. drop 6,000 / 600 lbs. rise	6"	4"	9-1/4" or 12-1/4"	1"	Gloss black



Two pin holes for varying length

Forged ball mounts

- Solid, forged steel for superior strength
- Compatible with anti-rattle to help stop vibration
- Also available with pre-torqued trailer ball



Part #	Shank Size	GTW / TW	Drop	Rise	Length	Tongue Hole Size	Finish
2" x 2" Xtra Duty Forged Ball Mounts							
45340	2" x 2"	17,000 / 2,550 lbs.	2"	1"	8-1/2"	1-1/4"	Carbide black
45341	2" x 2"	17,000 / 2,550 lbs.	4"	3"	8-1/2"	1-1/4"	Carbide black
45342	2" x 2"	17,000 / 2,550 lbs.	6"	5"	9-1/2"	1-1/4"	Carbide black
2-1/2" x 2-1/2" Commercial Duty Forged Ball Mounts							
45456	2-1/2" x 2-1/2"	20,000 / 2,700 lbs.	2"	1/2"	8-1/2"	1-1/4"	Carbide black
45458	2-1/2" x 2-1/2"	20,000 / 2,700 lbs.	4"	2-1/2"	8-1/2"	1-1/4"	Carbide black
45459	2-1/2" x 2-1/2"	20,000 / 2,700 lbs.	6"	4-1/2"	9"	1-1/4"	Carbide black
45460	2-1/2" x 2-1/2"	20,000 / 2,700 lbs. drop 16,000 / 2,160 lbs. rise	8"	6-1/2"	10"	1-1/4"	Carbide black
3" x 3" Industrial Duty Forged Ball Mounts							
45430	3" x 3"	21,000 / 2,800 lbs.	4"	2"	9"	1-1/4"	Carbide black
45431	3" x 3"	21,000 / 2,800 lbs.	6"	4"	10"	1-1/4"	Carbide black
45432	3" x 3"	21,000 / 2,800 lbs.	8"	6"	10-1/2"	1-1/4"	Carbide black





Adjustable channel mounts

- Adjustable channel allows for precise trailer leveling
- Shank can be flipped to maximize rise or drop
- Channels measure 3" wide (I.D.) with holes spaced 1" on center
- Pintle mounts include safety pin (#25012)
- Durable carbide black powder coat finish
- Includes pins & clips
- Patent #8,033,563 (excl #45901)

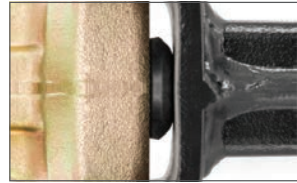

Integrated rubber dampener for enhanced vibration resistance

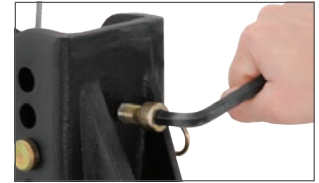

Built-in anti-rattle helps promote quiet towing (old-style)



45901



45900



45902



45907



45908



45926



45927



45928

Part #	Shank Size	Ball Mount GTW / TW	2" Ball GTW / TW	2-5/16" Ball GTW / TW	Max Drop	Max Rise	Length	Hole Size	Ball Finish
45901	2"	6,000 / 600 lbs.	--	--	6-3/4"	5-1/4"	11" or 12"	1"	--
45900	2"	--	10,000 / 1,000 lbs.	14,000 / 1,400 lbs.	6"	5-1/4"	11" or 12"	--	Yellow zinc-plated
45902	2-1/2"	--	10,000 / 1,000 lbs.	20,000 / 2,000 lbs.	6"	5-1/4"	11" or 12"	--	Yellow zinc-plated
45907	2"	--	--	13,000 / 1,300 lbs.	6"	5-1/4"	11" or 12"	1-1/4"	Chrome-plated
45908	2-1/2"	--	--	20,000 / 2,000 lbs.	6"	5-1/4"	11" or 12"	1-1/4"	Chrome-plated
45926	2"	--	10,000 / 1,000 lbs.	14,000 / 1,400 lbs.	10-1/8"	9-1/8"	11" or 12"	--	Yellow zinc-plated
45927	2-1/2"	--	10,000 / 1,000 lbs.	20,000 / 2,000 lbs.	10-3/8"	8-7/8"	11" or 12"	--	Yellow zinc-plated
45928	3"	--	10,000 / 1,000 lbs.	21,000 / 2,100 lbs.	10-5/8"	8-5/8"	11" or 12"	--	Yellow zinc-plated





Hitch step accessory

- Attaches to any CURT channel mount for versatile height adjustment (excl #45903)
- Cast steel construction with a highly durable black powder coat finish
- Folds up and out of the way when not in use

Part #	Tongue Weight	Step Width	Includes
45909	500 lbs.	16"	Hitch step only (no pins)



Adds a convenient 16" step on the front or rear of the vehicle

Accessory lock set

- Channel lock replaces one channel-mount pin
- 5/8" hitch lock fits 2" or 2-1/2" receiver tubes
- Locks keyed alike for convenient one-key operation

Part #	Includes
23556	One 5/8" hitch lock and one channel mount lock

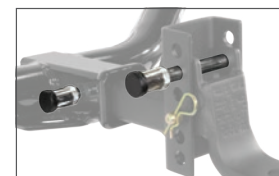

Secure the mount from theft

Slim adjustable channel mount

- Shank can be flipped to maximize rise or drop
- Weighs only 15 lbs. for easy handling, compared to other adjustable hitches
- One-pin dual-ball attachment for quick, easy adjustment
- Patent #8,033,563



Weighs only 15 lbs. for easy handling

Part #	Shank Size	2" Ball GTW / TW	2-5/16" Ball GTW / TW	Max Drop	Max Rise	Length	Ball Finish
45903	2"	8,000 / 800 lbs.	10,000 / 1,000 lbs.	3-3/4"	3-1/2"	10" or 11"	Yellow zinc-plated





Hitch pins & clips

- Secures ball mounts and other receiver tube inserts
- Bent handle for an easier grip



Bent handle for an easier grip during insertion and removal



Vinyl-coated pin & clip for a more solid, easy grip (select models)



Grooved pin allows clip insertion at any angle (select models)



High-strength steel construction with a durable zinc-plated finish

Bulk #	Pkg #	Three-Pack#	Fits Receiver Tube	Pin Diameter	Finish	Clip Attachment
21400	21401	--	1-1/4" x 1-1/4"	1/2"	Zinc-plated	Hole
21403	21404	--	1-1/4" x 1-1/4"	1/2"	Zinc-plated	Groove
21410	21411	--	1-1/4" x 1-1/4"	1/2"	Zinc-plated, coated grip	Hole
--	21502	--	1-1/4" x 1-1/4"	1/2"	Zinc-plated	Hole
			2" x 2"	5/8" adapter		
21500	21501	--	2" x 2"	5/8"	Zinc-plated	Hole
21504	21505	--	2" x 2"	5/8"	Zinc-plated	Groove
21510	21511	--	2" x 2"	5/8"	Zinc-plated, coated grip	Hole
21578	21579	--	2" x 2"	5/8"	Black zinc-plated	Hole
21580	21581	--	2" x 2"	5/8"	Zinc-plated	Hole
			2-1/2" x 2-1/2"			
21582	21583	--	2" x 2"	5/8"	Zinc-plated	Groove
			2-1/2" x 2-1/2"			
21507	21506	--	2-1/2" x 2-1/2"	5/8"	Zinc-plated	Groove
			3" x 3"			
21600	21601	21602	--	Fits 1/2" or 5/8"	Zinc-plated	--



Hitch locks

- Quickly secures ball mounts and other receiver tube inserts with no clip needed
- Permanently attached swivel clip cannot be lost
- Bent handle for an easier grip



Part #	Fits Receiver Tube Opening	Pin Diameter	Finish	Description
21541	1-1/4" x 1-1/4"	1/2"	Chrome-plated	Swivel pin
23581	1-1/4" x 1-1/4"	1/2"	Stainless steel	Swivel pin
21551	2" x 2"	5/8"	Chrome-plated	Swivel pin
23582	2" x 2"	5/8"	Stainless steel	Swivel pin
21561	1-1/4" x 1-1/4" 2" x 2"	1/2" 5/8"	Zinc-plated	Swivel pin with adapter sleeve



Quickly secures shank with no additional clip needed

Safety pins

- Quickly secures coupler latches, pintle hooks, jack legs or caster wheels
- Square retainer wire clip provides added clearance
- Protected by a durable zinc-plated finish



Bulk #	Pkg #	Pin Diameter	Pin Length	Chain Length
25080	25081	1/4"	2-3/4"	--
25012	25013	1/4"	2-3/4"	12" chain
25010	25011	5/16"	3"	--
25034	25035	5/16"	3"	12" chain
28278	28279	3/8"	2-3/4"	--
28000	28001	3/8"	3"	12" chain



25034 securing a coupler latch



28278 securing a jack foot



TOWING



Hitch locks

- Easy-to-operate, 1/4-turn lock activation
- Watertight dust cap prevents internal corrosion
- Space-saving, full-color retail packaging



23506



23502



23504



23510



23516



23517



23515



23501



23528



23519



23024



23020



23021

Part #	Tube Size	Pin Diameter	Finish	Lock Style
23020	1-1/4" x 1-1/4"	1/2"	Chrome-plated	Dead bolt
23501	1-1/4" x 1-1/4"	1/2"	Chrome-plated	Barbell
23024	1-1/4" x 1-1/4" 2" x 2"	1/2" 5/8"	Chrome-plated	Dead bolt with adapter sleeve
23517	1-1/4" x 1-1/4" 2" x 2"	1/2" 5/8"	Stainless steel	Barbell with adapter sleeve
23506	1-1/4" x 1-1/4" 2" x 2"	1/2" 5/8"	Chrome-plated with blue anodized aluminum	Barbell, right angle with adapter sleeve
23515	2" x 2"	5/8"	Chrome-plated	Barbell
23516	2" x 2"	5/8"	Stainless steel	Barbell
23518	2" x 2"	5/8"	Black	Barbell
23502	2" x 2"	5/8"	Stainless steel with blue anodized aluminum	Barbell, right angle
23510	2" x 2"	5/8"	Chrome-plated	Barbell, right angle
23528	Up to 2-1/2"	5/8"	Chrome-plated	Barbell
23519	Up to 2-1/2"	5/8"	Stainless steel	Barbell
23504	Up to 2-1/2"	5/8"	Chrome-plated with blue anodized aluminum	Barbell, right angle
23021	Up to 3"	5/8"	Chrome-plated	Dead bolt
23025	Up to 3"	5/8"	Chrome-plated	Barbell



23518



23025



Hitch & coupler lock sets

- Locks keyed alike for convenient one-key operation
- Easy-to-operate, 1/4-turn lock activation
- Watertight dust caps prevent internal corrosion
- Four keys included for added convenience
- Space-saving, retail packaging



Locks keyed-alike for convenient one-key operation



Watertight dust caps prevent internal corrosion



Trailer coupler locks fit flat lip couplers (size varies by model)



Easy-to-operate, 1/4-turn lock activation

Part #	Fits Receiver Tube Opening	Fits Latch Span	Fits Coupler	Lock Pin Diameter	Coupler Pin Diameter	Finish	Description
23526	2" x 2"	7/8"	--	5/8"	1/4"	Chrome-plated	Hitch lock (23515) & coupler lock (23520)
23527	2" x 2"	2-1/2"	--	5/8"	1/4"	Chrome-plated	Hitch lock (23515) & coupler lock (23522)
23505	2" x 2"	Adjustable from 1" to 3"	--	5/8"	1/4"	Chrome-plated	Hitch lock & coupler lock (23503)
23086	2" x 2"	Adjustable from 1/2" to 2-1/2"	1-7/8" and 2" flat lip couplers	5/8"	1/4"	Chrome-plated (hitch & coupler lock) Grey powder coat (trailer coupler lock)	Hitch lock, coupler lock & trailer coupler lock (23079)
23088	2" x 2"	Adjustable from 1/2" to 2-1/2"	2-5/16" flat lip couplers	5/8"	1/4"	Chrome-plated (hitch & coupler lock) Grey powder coat (trailer coupler lock)	Hitch lock, coupler lock & trailer coupler lock (23081)





Universal tri-ball coupler lock

- Highly theft and tamper-resistant design with built-in safety measures
- Simple lasso design keeps all parts together, avoiding lost pieces
- Glass-filled orange polymer for high strength and increased visibility
- Easy-to-operate, 1/4-turn lock activation
- Includes two keys for added convenience
- Patent pending



Unique tri-ball inserts into coupler and secures latch with lasso lock



Coupler lock can also be used while towing to secure the trailer



Built-in safety points allow the ball to break off when forcefully tampered with, leaving the ball in the coupler and blocking hookup



Part #	Fits Coupler Size	Fits Latch Span	Coupler Pin Diameter	Finish
23082	1-7/8", 2" and 2-5/16"	Adjustable from 1" to 3"	1/4"	Orange polymer

Coupler latch locks

- Easy-to-operate, 1/4-turn lock activation
- Watertight dust cap prevents internal corrosion
- Two keys included for added convenience
- Space-saving, full-color retail packaging



Part #	Fits Latch Span	Pin Diameter	Finish	Lock Style
23546	3/4"	1/4"	Solid brass	Padlock
23022	3/4"	1/4"	Brass-plated	Padlock
23521	3/4"	1/4"	Black	Padlock
23520	7/8"	1/4"	Chrome-plated	Barbell
23522	2-1/2"	1/4"	Chrome-plated	Barbell
23523	3-3/8"	1/4"	Chrome-plated	Barbell
23503	Adjustable from 1" to 3"	1/4"	Chrome with blue anodized aluminum	Barbell, right angle



Trailer coupler locks

- Designed to deter trailer theft by preventing a trailer ball from being inserted into the coupler
- Two keys included for added convenience



Part #	Fits	Finish	Description
23079	1-7/8" and 2" couplers	Grey powder coat	Aluminum lock for flat lip couplers
23081	2-5/16" couplers	Grey powder coat	Aluminum lock for flat lip couplers
23659	Universal	Hammer-tone epoxy	Die-cast trailer lock with dual-ratchet locking system
23179	Universal	Ballistic grade nylon	Solid, hardened steel trailer lock with dual-ratchet locking system

5th wheel hitch lock

- Locks a 5th wheel hitch into the rails, taking the place of a pin & clip
- Extra-long 1/2" diameter pin fits all industry-standard base rails
- Key slot angled upward for easier ergonomic access
- Easy-to-access, 1/8-turn lock activation

Part #	Pin Diameter	Finish
23256	1/2"	Black powder-coated aluminum



Flush-mount on the base rail for enhanced security

Kingpin lock

- Locks on to 5th wheel kingpin to deter theft
- Built with an aluminum body for corrosion resistance
- Two keys included for added convenience
- Space-saving, full-color retail packaging



Universal design fits most 5th wheel trailer kingpins

Part #	Description	Finish
23255	5th wheel trailer kingpin lock	Chrome-plated steel and powder-coated aluminum





Standard trailer balls

Chrome-plated



Stainless steel



Raw

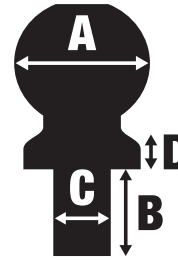

Measuring a trailer ball

- A: Ball diameter
- B: Shank length
- C: Shank diameter
- D: Rise

Shank Diameter (C)	Shank Length (B)	Rise (D)	GTW	Chrome Bulk #	Chrome Full Throne #	Chrome Half Throne #	Stainless Bulk #	Stainless Full Throne #	Raw Bulk #
1-7/8" Ball Diameter (A)									
3/4"	1-5/8"	0"	2,000 lbs.	40001	40061	40161	--	--	--
3/4"	2-1/8"	0"	2,000 lbs.	40015	40063	--	40050	40080	--
3/4"	3"	0"	2,000 lbs.	40016	40071	--	--	--	--
1"	2-1/8"	0"	3,500 lbs.	40002	40062	40162	40051	40081	--
1"	2-1/8"	2"	3,500 lbs.	40032	--	--	--	--	--
1"	2-3/16"	1"	3,500 lbs.	40031	--	--	--	--	--
1"	3"	0"	3,500 lbs.	40017	40072	--	--	--	--
2" Ball Diameter (A)									
3/4"	1-3/4"	0"	3,500 lbs.	40003	40064	40164	--	--	--
3/4"	2-1/8"	0"	3,500 lbs.	40018	40065	--	40052	40082	--
3/4"	3"	0"	3,500 lbs.	40019	40073	--	--	--	--
1"	2-1/8"	0"	6,000 lbs.	40004	40066	40166	40053	40083	--
1"	2-1/8"	0"	7,500 lbs.	40037	40070	40170	--	--	--
1"	2-1/8"	1"	6,000 lbs.	40033	--	--	--	--	--
1"	2-1/8"	2"	6,000 lbs.	40034	--	--	--	--	--
1"	2-1/4"	0"	12,000 lbs.	40038*	--	--	--	--	--
1"	3"	0"	6,000 lbs.	40020	40074	--	--	--	--
1-1/4"	2-5/8"	0"	10,000 lbs.	40090	40069	40190	40056	--	--
2-5/16" Ball Diameter (A)									
1"	2-1/8"	0"	7,500 lbs.	40005	40067	40167	40054	40084	--
1"	2-1/4"	0"	10,000 lbs.	40007	--	--	--	--	--
1"	2-1/4"	0"	12,000 lbs.	40039*	--	--	--	--	40042*
1"	3"	0"	6,000 lbs.	40021	40075	--	--	--	--
1-1/4"	2-5/8"	0"	10,000 lbs.	40006	40068	40168	--	--	--
1-1/4"	2-5/8"	0"	15,000 lbs.	40030*	40078*	40178*	40055	--	--
1-1/4"	2-5/8"	0"	30,000 lbs.	--	--	--	--	--	40085*
1-1/4"	2-5/8"	1"	10,000 lbs.	40035	--	--	--	--	--
1-1/4"	2-5/8"	1"	25,000 lbs.	--	--	--	--	--	40086*
1-1/4"	2-5/8"	2"	10,000 lbs.	40036	--	--	--	--	--
1-1/4"	2-5/8"	2"	25,000 lbs.	--	--	--	--	--	40087*
1-1/4"	2-3/4"	0"	20,000 lbs.	40008*	40009*	--	--	--	--
1-1/4"	3"	0"	6,000 lbs.	40022	40076	--	--	--	--
2"	3-1/2"	0"	30,000 lbs.	--	--	--	--	--	40088**
3" Ball Diameter (A)									
2"	3-1/4"	0"	30,000 lbs.	--	--	--	--	--	40089**
50mm Ball Diameter (A)									
3/4"	50mm	0"	1,600 kg.	40099	--	--	--	--	--

* Heat-treated

** Heat-treated, coarse-threaded





NO-LATCH. HASSLE FREE. ONE-PIN COUPLING.

QuickPin™ no-latch couplers

- Easier to use than traditional couplers
- No adjustments or tightening needed
- Fastens securely with included 1/2" diameter pin and clip (also accepts a 1/2" hitch lock)

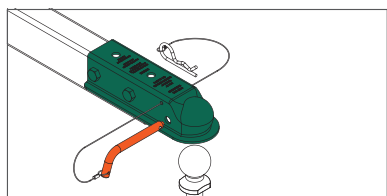

No latch, one-pin coupling is easier to use than traditional couplers

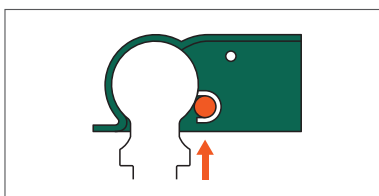

Innovative design allows fast, hassle-free trailer hookup with just one pin

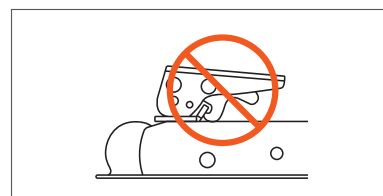

No jamming or complicated hinging components prone to wear

Anti-rattle hitch clamps

- Stops rattling and prevents shank movement
- Compatible with hollow and solid shank accessories
- No-tool installation and easy-to-adjust clamp lever
- Lightweight aluminum and high-strength steel
- Durable, clear finish for corrosion resistance





DASH INTEGRATION FOR OE LOOK AND FEEL

Universal truck bed extender

- Unique, folding tailgate for easier cargo access, no flip-up required
- Universal design fits most full-size truck beds, including short and long beds
- Innovative pin-latch system for fast installation and removal as needed
- No drilling or bed modifications required
- Extends 6-1/2' beds to 8-1/2' and 8' beds to over 10'
- Squared off corners maximize cargo space, unlike rounded models
- Three-piece design easily disassembles for compact storage and easy handling
- Weighs only 40 lbs. for stress-free handling
- Compatible with most tonneau covers
- Strong tubular steel construction with durable carbide black powder coat finish
- May not fit with flare-style tailgates



Part #	Height		Outside Dims		Inside Dims	
	Back	Front	Width	Length	Width	Height
18325	19-3/4"	17"	60-1/2"	29"	58-3/4"	26-1/2"



Unique, folding tailgate for easier cargo access, no flip-up required



Innovative pin-latch system for fast installation and removal as needed. No drilling required



Three-piece design easily disassembles for compact storage and easy handling



CARGO CARRIERS

Aluminum cargo carrier with ramp

- Three-position ramp can be extended, folded vertically or stowed in the carrier
- Double-folding ramp for ergonomic operation and less wind resistance
- Ramp folds flat into the carrier for compact storage and rear vehicle access
- 2" threaded anti-rattle shank to resist sway and suppress noise
- Non-skid ridges provide enhanced traction when moving up or down the ramp
- Built-in reflectors add visibility for increased safety
- 8-bolt assembly for fast, easy installation
- Fully welded aluminum construction
- 50" (L) x 30-1/2" (W) x 4" (H) with 500-lb. capacity



18112



Built-in ramp for easy loading of scooters, push mowers, snow blowers and more



When not in use, carrier folds up for convenient parking and storage



Six integrated eye bolts for secure attachment of straps or other tie-downs

Basket-style cargo carriers

- 6" tall sides keep items more secure during travel
- Available in steel or lightweight aluminum options
- Folding shank allows carrier to be tilted up (select models)
- Angled shank allows for more ground clearance (select models)
- Ask about our full-line of options



18150



18113

Cargo bags and nets

- Bags feature UV-resistant vinyl with welded seams and zip closure to be weather-resistant
- Nets secure cargo from dislodging during travel



18220



TOWING

TOWING

DEMCO

VICTORY SERIES TOW BARS

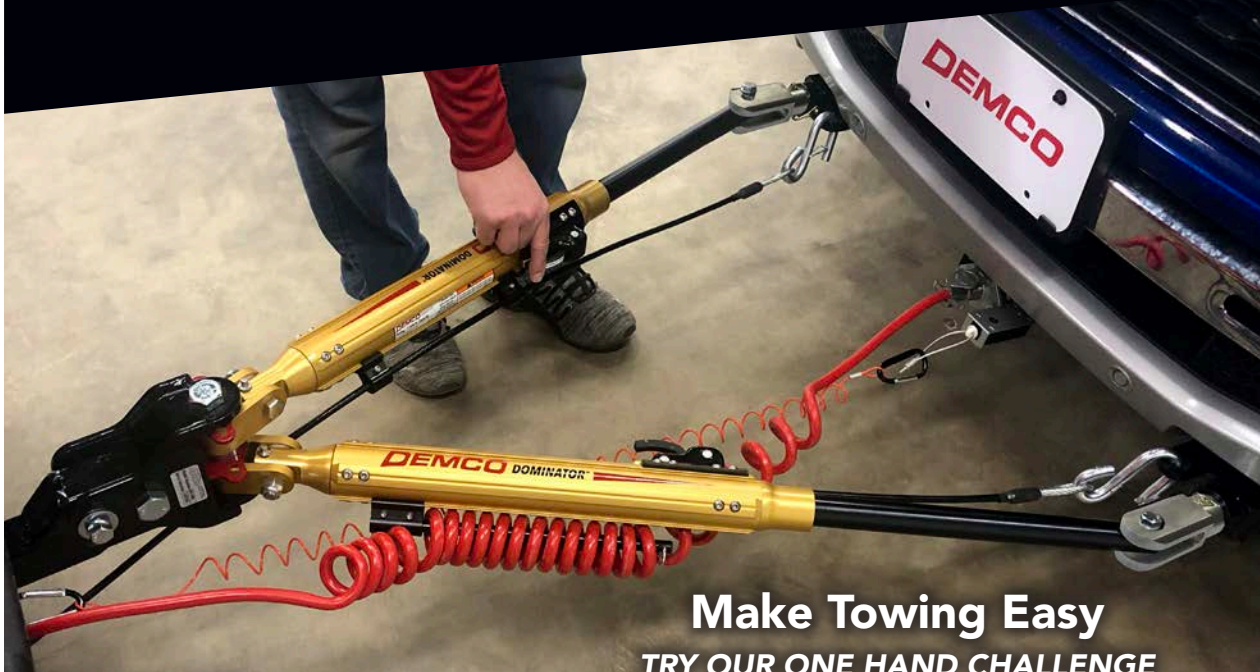

Make Towing Easy
TRY OUR ONE HAND CHALLENGE

Patent # 6502847, 6612604, 6764092, 7837216

DEMCO
DOMINATOR™



LIGHTWEIGHT

9511008 - Dominator™

Weighs: 30 lbs.
 Tows: 7,500 lbs.

DEMCO
COMMANDER™ 2



ECONOMICAL

9511012 - Commander 2™

Weighs: 41 lbs.
 Tows: 6,000 lbs.

DEMCO
EXCALI-BAR™ 3



HEAVY DUTY

9511013 - Excali-Bar 3™

Weighs: 46 lbs.
 Tows: 10,500 lbs.



LIMITED
 WARRANTY
 LIFETIME



Self-supporting
 arms



SAFETY
 Safety cables
 included



Easy trigger
 release



Rise or drop
 male receiver



Adjustable
 towing angle



MADE IN
 USA





TOWBAR ACCESSORIES

SENTRY DEFLECTOR™



Strong but lightweight and flexible



Deflect debris away from vehicle



Easy to install and remove

Tow Bars - 9523135

Tow Dollies - 5950

TOW BAR ACCESSORIES

PART DESCRIPTION	PART #	PART DESCRIPTION	PART #
TOWING COMBO KITS:		LOCKING PINS:	
Diode System Combo Kit	9523057	5/8" Locking Hitch Pin	9523066
Kit includes: 6 Way Coiled Lighting Cable, Diode Wiring Kit, Marine Grade Vinyl Demco Storage Cover, Three Pin Locking Kit, 7 to 6 Way Adapter		Two Locking Baseplate Pins	9523067
WIRING KITS:		Three Pin Locking Kit	9523068
Towed Vehicle Taillight Wiring/ Diode Kit	9523010	Two Quick Pins *	9523045
7 to 6 RV Adapter	9523053	Two Standard Pins w/ Quick Pins *	9523046
Diode Kit (4 Diodes)	9523063	ACCESSORIES:	
FLEX-COILED WIRING CABLES:		3 1/2" Receiver Extension	9523052
4 Way Coiled Lighting Cable	9523004	4" Drop/Raise Receiver for Victory Series Tow Bars	9523059
6 Way Coiled Lighting Cable	9523006	6" Drop/Raise Receiver for Victory Series Tow Bars	9523060
7 to 6 Way Coiled Lighting Cable	9523054	Tow Bar Storage Cover	9523042
7 to 4 Way Coiled Lighting Cable	9523069	Pull Ear Covers *	5899
SAFETY CABLES:		Tablets Covers	15675
54" Straight Safety Cables *	9523051	SENTRY DEFLECTOR ADAPTERS:	
64" Straight Safety Cables *	9523055	For Stowmaster™, Blue Ox™ RV mounted tow bars to Roadmaster™ base plate	9523027
86" Coiled Safety Cables *	9523003	For Blue Ox base plate	9523061
12" Safety Cable Extensions *	9523064		
18" Safety Cable Extensions *	9523065		

* Sold per pair

NEW

WIRELESS LED LIGHT BAR

- No cutting and splicing into your vehicle wiring
- No wires running from the coach to the towed vehicle
- Wireless technology
- Transmitter and Light Bar are paired to eliminate interference
- Transmitter plugs into the 7 way plug on your coach
- The Light Bar mounts in the rear window of the towed vehicle utilizing a heavy-duty RAM mount and is powered by 12V port from the towed vehicle



DEMCO

TABLESS & CLASSIC BASEPLATES



Exclusively from **DEMCO** - TABLESS BASEPLATES



Available for most current models of tow cars
FOR FIT LIST AND AVAILABILITY
 SCAN THIS QR CODE or go to
<https://bit.ly/3rw1KCB>



Neat, clean
Look



Secure, reliable
attachment to
chassis



Easy hook-up
and disconnect



TABLESS BASEPLATE ADAPTERS

** Adapts Demco tabless baseplates to other manufacturers' tow bars*

PART DESCRIPTION	PART #
Blue Ox Tow Bar (Aval, Aventa, Aladdin, Alpha, Acclaim, Allure)	9523127
Road Master Tow Bar (Falcon 2, StowMaster, StowMaster All-Terrain)	9523128

CLASSIC STYLE BASEPLATE ADAPTERS

** Adapts Demco baseplates to other manufacturers' tow bars*

PART DESCRIPTION	PART #
Roadmaster Eagle™ & Eagle 8000™	9523014
Valley Ind. Utility Tow Bar & Reese® Tow Champ	9523015
Roadmaster Falcon 5250	9523023
Blue Ox® Aladden®, Aventa® II, Aventa® LX and Alexis	9523034
Roadmaster Tracker, Falcon 2, Falcon All Terrain, Blackhawk and Blackhawk All Terrain™ and Sterling™ tow bars with serial numbers up to 14,500	9523036
Roadmaster Sterling All Terrain™ & Sterling Tow Bars with Serial #'s above 14,501	9523062

CLASSIC STYLE BASEPLATE ADAPTERS

** Adapts Demco tow bars to other manufacturers' baseplates*

PART DESCRIPTION	PART #
Roadmaster Baseplates including XL or EZ 2, EZ 4 Series	9523001
Duncan Baseplate	9523017
Reese® Tow Champ & Valley Ind. Utility Tow Bar, Bumper Brackets	9523019
Roadmaster MS, MX, and EZ 5 Series Baseplates	9523032
Blue Ox Baseplates	9523041





#1 IN TOWED VEHICLE BRAKING

MFG	SYSTEM	5 YR WARRANTY	DUAL SIGNAL	PROPORTIONAL BRAKING	INSTALLED	PORTABLE
Demco	Air Force One	✓		✓	✓	
Demco	Stay-IN-Play DUO	✓	✓		✓	
Demco	Delta Force	✓	✓			✓

AIR FORCE ONE (AFO) For Air Brake

- Only air brake to meet DOT and chassis regulations
- Fits every car and motorhome
- No pulleys, catches, or springs
- Breakaway integrated



Air Force One Braking System	9599007
AFO with Wireless Coachlink	9599019
AFO Second Car Kit	6271
AFO Reinstall Kit	6217
AFO Freightliner Custom Chassis Specific Towed Vehicle Kit	9599020
AFO Tiffin Towed Vehicle Kit	9599021



US Patent 7,699,406

STAY-IN-PLAY DUO For Hydraulic Brake Motorhome

- Fits every car and motorhome
- No pulleys, catches, or springs
- Breakaway integrated

Stay-In-Play Duo Braking System	9599006
Stay-In-Play Duo Braking System with Wireless Coachlink	9599018
Stay-In-Play Duo Braking System Reinstall Kit	6270



US Patent 6,644,761

DELTA FORCE Universal Portable Solution

- Flexball actuator mount
- Wireless Coachlink
- Set-It-Once Pedal Clamp
- Breakaway integrated

Delta Force Braking System	9599004
Delta Force Second Car Kit	6221

75% smaller than competitor models



WIRELESS COACHLINK™ Universal for all Braking Systems

- Plugs into coach power port
- Instant visual feedback that brakes are applied
- Transmits signal from towed-vehicle
- Positive "Brakes on" light
- Audible tone indication lets you know your braking system is working flawlessly

Wireless Radio Set

9599005



SUPPLEMENTAL BRAKING SYSTEM ACCESSORIES

PART DESCRIPTION	PART #	PART DESCRIPTION	PART #
Stand Off Bracket for Delta Force	6274	AFO Second Car Kit	6271
Gives extra 2" of space between the box and brake arm connection		Delta Force Second Car Kit	6221
Smart Car Bracket For Stay-IN-Play Duo and AFO	6227	AFO reinstall Kit	6217
Vacuum Tee Kit For Stay-IN-Play Duo and AFO	6257	Stay-IN-Play Duo Reinstall Kit	6270
Standard AFO Coiled Airline	6212	Coach Air Kit	6231
Spartan Specific Coil Airline	6296	Battery Disconnect Switch	6338
Freightliner Custom Chassis Specific Air Jumper	6376	SBS Air Tester	6339
AFO Air Pressure Stop Switch	6232	12V Power Outlet	6342
Replacement AFO Air Cylinder	6210	Charge Wire Kit	6252
Replacement Stay-IN-Play Duo Air Cylinder	6215	Air Cylinder Cable Repair Kit	6337
AFO - Stay-IN-Play Duo Conversion Kit	6218	Jeep Cherokee Brake Arm Bracket	6356
Stay-IN-Play Duo - AFO Conversion Kit	6220		



TOWING

TOWING

DEMCO

TOW DOLLIES

Custom Chrome Wheels
Radial tires make this dolly one you'll be proud of for years to come

Durable Galvanized Finish
For years of corrosion free use

Less than 100 lbs. Tongue Weight When Loaded
For improved ride and handling of towed vehicles

Tilt-bed Frame
Provides fast, easy loading. Positive locking mechanism on tilt-bed; does not require a separate loose pin

Hinged Tongue
Hitch folds back to promote minimal storage capacity

Auto Steer
Steerable axle allows for tighter turns

Folding Ramps
Ramps fold up to allow for comfortable fit in almost any RV park or garage

Shown: Karkaddy SS

DEMCO

KARKADDY SS

9713045

Fully extended: 133 inches long
Folded: 67 inches long
Total towed vehicle weight: 4,800 lbs.
Axle capacity: 3,500 lbs.
Towed vehicle tread width: 42" min., 76" max.
Galvanized finish

DEMCO

KARKADDY X

9713093

Fits low profile vehicles
Towed vehicle tread width: 42" min., 78" max.
Total towed vehicle weight: 4,800 lbs.
King pin design swivel platform
Black powder coat paint finish with hot dipped galvanized components

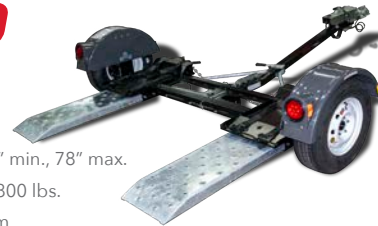

on Sealed bearing hubs



EZ Latch Coupler



Radial tires dual safety chains



Hydraulic surge disc brakes



Low loading clearance



MADE IN USA

TOW DOLLY ACCESSORIES:

<p>Wheel Jack</p>  <p>11683</p>	<p>Wireless Light Bar NEW</p>  <p>6343</p>	<p>Loading Winch w/Strap Assembly</p>  <p>KK2W</p>	<p>Spare Tire Mount (black)</p>  <p>RKSTM</p>	<p>Spare Tire w/Chrome Rim</p>  <p>5968</p>	<p>Spare Tire w/White Rim</p>  <p>5965</p>
<p>Sentry Deflector</p>  <p>5950</p>	<p>Steering Wheel Strap</p>  <p>5975</p>	<p>Standard Straps (shipped on dolly)</p>  <p>03528</p>	<p>Small Straps</p>  <p>03528-81</p>	<p>Large Straps</p>  <p>03528-93</p>	



AUTOSLIDE 13, 18 & 21K 5th WHEEL HITCHES

13K AUTOSLIDE

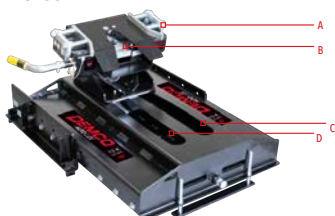

- A. **No locking plate required** for standard pin boxes to activate slide mechanism
- B. **Wrap around jaw** with locking bar for a smoother, safer, and more secure ride
- C. **22 1/2 INCHES** of travel to help get in and out of those tight spots
- D. Up to 2 3/4" side-to-side travel to keep your pin-box from hitting bed rails or Tonneau-cover rails

18K & 21K ABOVE BED MOUNT

Industry Standard Bed Rails Included

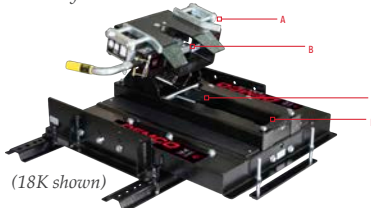

(18K shown)

- A. **No locking plate required** for standard pin boxes to activate slide mechanism
- B. **Wrap around jaw** with locking bar for a smoother, safer and more secure ride
- C. Slides utilize rack and pinion gear technology
- D. Up to 14" of travel to help get in and out of those tight spots

18K & 21K ABOVE BED MOUNT

Bed Rails NOT Included



(21K shown)

18K & 21K UNDER BED MOUNT (UMS)



(18K shown)

Additional Autoslide Information:

- Fits industry standard rails
- Low profile design
- Easy access for routine maintenance
- See 5th Wheel Accessory page for OE prep fits
- 3 vertical height adjustments to help you level truck and trailer

* Frame Mounting Brackets must be ordered separately

* Need locking plate with *Glide Ride, Mor Ryde, Trailair Tri Glide, Trailair Flexair, Rota Flex or 5th Airborne pin boxes*



PART DESCRIPTION	PART #
13K Above Mount <i>Industry Standard Bed Rails Included</i>	8550047
13K Above Bed Mount <i>Bed Rails NOT Included</i>	8550048
13K Under <i>Bed Mount (UMS)</i>	8550049

PART DESCRIPTION	PART #
18K Above Bed Mount <i>Industry Standard Bed Rails Included</i>	8550023
18K Above Bed Mount <i>Bed Rails NOT Included</i>	8550034
18K Under Bed Mount (UMS)	8550022
18K Under Bed Mount (UMS) <i>Ford Prep Package</i>	8550024
21K Above Bed Mount <i>Industry Standard Bed Rails Included</i>	8550036
21K Above Bed Mount <i>Bed Rails NOT Included</i>	8550035
21K Under Bed Mount (UMS)	8550037
21K Under Bed Mount (UMS) <i>Ford Prep Package</i>	8550038

Locking Plates

For use with Autoslide in conjunction with a Pin Box listed below

PART DESCRIPTION	PART #
Lippert Rhino Pin Box	6335
Trailair Tri Glide	6095
Trailair Rota Flex & Trailair Flexair	6171
MOR/Ryde Pin Box	6025
5th Airborn Standard Pin Box	6026
5th Airborn Extended Pin Box	6062
Demco Glide Ride Pin Box	6036
For Lippert Turning Point and New 5th Airborne Pinbox	6285

AUTOSLIDE FACTORY OE 5TH WHEEL PREP ORDERING GUIDE

Truck	18K Auto Slide		21K Auto Slide		+	OEM 5th Wheel Prep Bracket			
	8550024	8550034	8550035	8550038		6099	2016-2019 6194 (6.5' bed)	2016-2019 6200 (8' bed)	2020-2021 6333 (6.5' & 8' bed)
Ford F250/350	✓			✓		(Not needed in a Ford Application)			
Chevy/GMC 2500/3500		✓	✓			✓		✓	✓
Chevy/GMC 2500/3500		✓	✓			✓		✓	✓
Ram 2500/3500		✓	✓			✓			
Nissan Titan		✓					✓		



DEMCO

RECON 5TH WHEEL HITCH

THE NEWEST MEMBER OF THE RECON FAMILY

NOW IN A SLIDER APPLICATION

- Simple assembly
- 14" of travel
- Lightweight



RECON SLIDER 5TH WHEEL HITCH

DEMCO RECON

2
PIECES
Easy install
and removal

Light
weight

MADE IN
USA



Recon for bed rails



Recon for Gooseball



Recon for Recessed
Gooseball



Recon Slider for
bed rails

No additional adapter plates or cables needed to install on a king pin

- Four applications: Stationary and Manual Slider for Industry Standard bed rails, Gooseball mount & Recessed Gooseball mount
- Gooseball mount fits any standard 2-5/16" Gooseneck ball
- Flat deck applications with Recessed Gooseneck ball
- The new Recon Slider allows for 14" of rearward travel
- Wrap around jaw with lock bar for stronger, more secure, safer towing experience
- Dual articulation head for easy hookup and release on uneven terrain
- 3 height adjustments 15-1/2" to 18" for 8550043, 8550044, 8550045
- 3 height adjustments 15-1/8" to 18" for 8550052, 8550053
- 3 height adjustments 11-1/2" to 14" for 8550046
- 21,000 towing capacity

PART DESCRIPTION	PART #
ISR Mount (rails not included)	8550043
ISR Mount (rails included)	8550044
2 5/16" Goose Ball Mount	8550045
Flat Deck (recessed 2 5/16" Goose Ball Mount)	8550046
NEW Recon Slider (rails not included)	8550052
NEW Recon Slider (rails included)	8550053





21K & 31K HITCHES, AND OE ADAPTERS



21K UMS SERIES (UNDER BED MOUNT, FORD PREP & GMC PREP)

- 21K towing capacity
- Long box application
- Four vertical height adjustments 16" to 19"

8550032 – UMS Series

- Frame mounting brackets must be ordered separately

8550033 – Ford 2011-Present Prep Package

8550050 – Chevy/GMC 2020-Present Prep Package



31K UMS SERIES (UNDER BED MOUNT FOR CHEVROLET/GMC PREP, FORD PREP, AND RAM PREP)

- 31K towing capacity
- Long box application
- Four vertical height adjustments 16" to 19"
- Wrap Around Jaw with locking bar for a smoother, safer and more secure ride

8550054 – Ford 2011-Present Factory Prep Install

8550055 – Chevy/GMC 2016-2019 Factory Prep Install

8550056 – Chevy/GMC 2020-Present Factory Prep Install

8550057 – Ram 2013-Present Factory Prep Install

THE LEADER IN OE ADAPTERS!

B&W

Converts the B&W ball mount to a 21K ISR rail system. Adjustable for bed liners

**Not for use with automatic sliding hitches*



6140

Ford 5th Wheel Prep Bracket

25K rated industry standard rail system for installed 5th wheel prep hitch package



6175

F250 & F350: 2011-2021

Ram 5th Wheel Prep Bracket

25K rated industry standard rail system for installed 5th Wheel Prep Hitch Package



6099

2500: 2014-2021
3500: 2013-2021

Chevrolet/GMC 5th Wheel Prep Brackets

21K rated industry standard rail system for installed 5th wheel prep hitch package



6333 for 6.5' & 8' Bed

2500 & 3500: 2020-2021

Nissan 5th Wheel Adapter

21K rated industry standard rail system for installed 5th wheel prep hitch package



6200

Titan XD: 2016-2021



6206 for 8' Bed

6194 for 6.5' Bed

2500 & 3500: 2016-2019





UMS SERIES, OE ADAPTERS AND ACCESSORIES

Bed Rails included. Frame mounting brackets must be ordered separately.

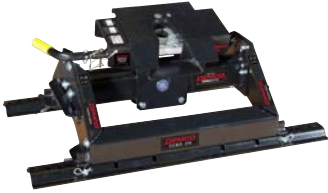

PREMIER SERIES DOUBLE PIVOT

16K – 8550025 21K – 8550027

- 16K & 21K towing capacities
- Long box application
- Four vertical height adjustments 16" to 19"
- See Demco 5th wheel accessories page for 5th wheel prep truck mounting kits



SL SERIES DOUBLE PIVOT SLIDER

16K – 8550029 21K – 8550030

- Wrap around jaw with locking bar for a smoother, safer and more secure ride
- Long/Short Box Application 16" to 19"
- 16K & 21K towing capacities
- Double pivot head with polyurethane bumpers
- Four vertical height adjustments
- Upgrade kits available to change with your towing needs

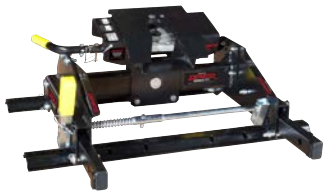

PREMIER SERIES DOUBLE PIVOT SLIDER

16K – 8550026 21K – 8550028

- 16K & 21K towing capacities
- Short box application
- Four vertical height adjustments 16" to 19"
- See Demco 5th wheel accessories page for 5th wheel prep truck mounting kits



SL SERIES FLAT DECK

21K – 8550042

- Double pivot head w/ polyurethane bumpers
- Wrap around jaw with locking bar for a smoother, safer and more secure ride
- Long/Short Box Application
- 21,000 lb Towing Capacity

ACCESSORIES:

PART DESCRIPTION	PART #
Bed Rail Kits	
SL Series Bed Rail Kit	6012
Ultra Series Bed Rail Kit	6014
Premier Series Bed Rail Kit (fits industry standard rails)	6071
5th Wheel Wiring Harness	
7'	8555001
10'	8555002
5th Wheel Upgrade Kits	
<i>Upgrade to a 21K hitch</i>	
Upgrade 8550019 or 8550026 to 21K towing capacity for Premier Series Ultra Slide	6052
Ultra Slide Upgrade Kits	
<i>Upgrade to a manual slide hitch</i>	
Premier Series Ultra Slide Upgrade Kit	6055

5th Wheel Vinyl Cover



14844

Gooseneck Adapters



SL Series 25K Gooseneck 5992
Premier/Ultra Series 25K Gooseneck 5996
UMS Gooseneck 5988

Hitch Lifter



6100

Make lifting your Demco 5th wheel hitch easier with the hitch lifter. Just snap it into the 5th wheel jaws and use an engine lift or chain hoist to lift your Demco 5th Wheel out of the bed of your truck.



Contact Demco at 1-800-543-3626 if your installation bracket kit is not listed

DEMCO 5TH WHEEL FRAME MOUNTING BRACKET KITS

VEHICLE	YEAR	UMS SERIES UNDER BED MOUNT	PREMIER SERIES	SL SERIES
FORD				
F150 (5 1/2', 6 1/2' & 8' Boxes)	2015-2021	N/A	8552028	8553015
F150 (5 1/2', 6 1/2' & 8' Boxes)	2004-2014	8551001	8552003 or 8552004	8553002
F150 (6 1/2' & 8' Boxes)	1997-2003	N/A	8552009	8553004
F250/350 "Super Duty" (6 1/2' & 8' Boxes)	2017-2021	8551009	8552031	8553017
F250/350 "Super Duty" (6 1/2' & 8' Boxes)	2011-2016	8551000	8552000	8553000
F250/350 "Super Duty"	2005-2010	8551000	8552001 or 8552002	8553001
F250/350 "Super Duty" (6 1/2' & 8' Boxes)	1999-2004	8551000	8552006	8553003
F250 "Light Duty" (6 1/2' & 8' Boxes)	1997-2003	N/A	8552009	8553004
F450 "Super Duty"	2017-2021	8551009	8552031	8553017
F450 "Super Duty"	2011-2016	8551000	8552000	8553000
F450 "Super Duty"	2008-2010	8551000	8552001 or 8552002	8553001
F450/550 "Chassis Cab"	2000-2007	N/A	8552005	Not recommended
CHEVROLET/GMC				
Silverado & Sierra 1500 Crew Cab 5 1/2', 6 1/2' and 8'	2019-2021	8551011	8552034	8553019
Silverado 1500 LD & GMC Sierra Limited Double Cab 6-1/2' Bed	2019-2020	8551008	8552027	8553014
Silverado & Sierra 1500 (5 1/2', 6 1/2' & 8' Bed) Regular, Double, and Crew Cab	2014-2018	8551008	8552027	8553014
Silverado & Sierra 1500 (6 1/2' and 8' Box) (tube frame)	2007-2013	8551005	8552009 or 8552013	8553004
Silverado & Sierra 1500 (5 1/2' Box)	2007-2013	8551008	8552009 or 8552013	8553004
Silverado & Sierra 1500 (6 1/2' & 8' Boxes)	1999-2007	8551004	8552009	8553004
Silverado/Sierra 1500 HD (6 1/2' & 8' Boxes)	2001-2007	8551004	8552009	8553004
Silverado/Sierra 1500 (5 1/2' Box)	2004-2006	8551008	8552009	8553004
Silverado/Sierra 2500 & 3500 HD (6 1/2' box)	2020-2021	8551012	8552037	8553020
Silverado/Sierra 2500 & 3500 HD (8' box)	2020-2021	8551012	8552038	8553020
Silverado/Sierra 2500 & 3500 HD (6 1/2' & 8' box)	2011-2019	8551010	8552011	8553007
Silverado/Sierra 2500 & 3500 HD (6 1/2' & 8' Boxes) (Includes New Body Style)	2001-2010	8551004	8552009 or 8552012	8553004
Silverado & Sierra 2500 (6 1/2' & 8' Boxes)	1999-2007	8551004	8552009	8553004
Silverado/Sierra 3500 (6 1/2' and 8' Box)	1988-2001	N/A	8552009	8553009
DODGE				
Ram 1500 (5 1/2', 6 1/2' & 8' Boxes) No Air Suspension Includes Diesel	2019-2021	N/A	8552032	8553018
Ram 1500 Classic (5 1/2', 6 1/2' & 8' Boxes) No Air Suspension Includes Diesel	2019-2021	N/A	8552030	8553010
Ram 1500 (5 1/2', 6 1/2' & 8' Boxes) No Air Suspension Includes Diesel	2009-2018	N/A	8552030	8553010
Ram 1500 (4x2 & 4x4)(6 1/2' & 8' Boxes)(Includes Mega Cab)	2002-2008	8551005	8552015 or 8552016	8553004
Ram 1500	1994-2001	N/A	8552009	8553003
Ram 2500 (4x2 & 4x4)(6 1/2' & 8' Boxes) (Includes Mega Cab) (Includes Auto Level Rear Air Suspension)	2014-2021	N/A	8552025	8553016
Ram 2500 (4x2 & 4x4)(6 1/2' & 8' Boxes) (Includes Mega Cab)	2013	8551005	8552015 or 8552023	8553004
Ram 2500 (4x2 & 4x4)(6 1/2' & 8' Boxes) (Includes Mega Cab)	2003-2012	8551005	8552015 or 8552016	8553004
Ram 2500 (6 1/2' & 8' Boxes)	1994-2002	N/A	8552009	8553003
Ram 3500 (4x2 & 4x4)(6 1/2' & 8' Boxes) (Includes Mega Cab)	2019-2020	8551006*	8552036	8553013*
Ram 3500 (4x2 & 4x4)(6 1/2' & 8' Boxes) (Includes Mega Cab)	2013-2018	8551006*	8552026	8553013*
Ram 3500 (4x4 only)(6 1/2' & 8' Boxes) (Includes Mega Cab)	2003-2012	8551005	8552015 or 8552016	8553004
Ram 3500 (4x2 only)(6 1/2' & 8' Boxes) (Includes Mega Cab)	2003-2012	8551005	8552017	8553004
Ram 3500 (6 1/2' & 8' Boxes)	1994-2002	N/A	8552009	8553003
Dakota (6 1/2' Box)	2005	N/A	8552019	8553003
Dakota (6 1/2' Box)	2003-2004	N/A	8552005	8553003
Dakota	2002 & earlier	N/A	8552009	8553003
TOYOTA				
Tundra (5 1/2', 6 1/2' & 8' Boxes)	2007-2021	N/A	8552020	N/A
Tundra (6 1/2' & 8' Boxes)	2001-2006	N/A	8552009	Not recommended
Tacoma	2001 & Earlier	N/A	N/A	8553012
T100	2000 & Earlier	N/A	8552009	8553012
NISSAN				
Titan (5 1/2', 6 1/2', 7' & 8' Boxes)	2017-2021	N/A	8552033	N/A
Titan (6 1/2', 7' & 8' Boxes)	2004-2015	N/A	8552021	N/A

Check www.demco-products.com for latest updates

*Not with "Auto Level Rear Air Suspension" option

NO DRILL ATTACHMENT INDICATED IN RED

Scan the QR code to find the correct frame bracket for your make and model of truck





DEMCO TRAILER COMPONENTS

DEMCO ACTUATORS

Demco offers the widest selection of hydraulic brake actuators available today. Our mounts, including A-Frame, weld-on, bolt-on and several universal mounts are industry standard, offering applications suited to your needs.

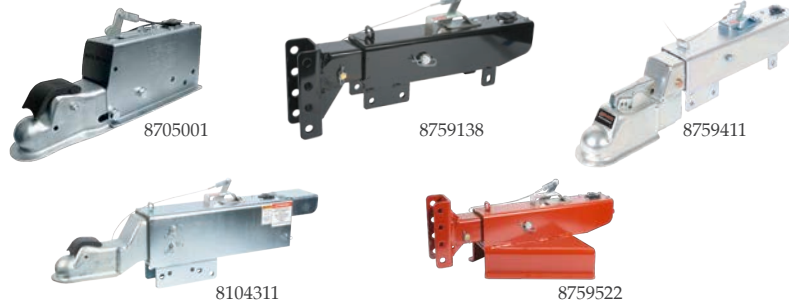

PART DESCRIPTION	PART #
DA66B 6000 lb. G.V.W.R. Plated, top mount, lever lock coupler	8605001
DA91 8000 lb. G.V.W.R. Down, 3 hole standard, black	8759138
DA91 8000 lb. G.V.W.R. Down, 3 hole standard, zinc	8759411
DA10 12,500 lb. G.V.W.R. Down, 5 bolt universal, zinc	8104311
DA91 8,000 lb. G.V.W.R. Center, 50° mount, primed	8759522

DEMCO EZ LATCH COUPLERS

Demco has an exclusive EZ Latch coupler design which automatically locks when dropped over it's appropriately sized standard hitch ball.

The EZ Latch coupler is offered in an array of different hitch mounts in both 2" and 2 5/16" ball coupler sizes. Mounting configurations include: weld-on and bolt-on for 3" tube, A-frame weld-on, and bolt-on adjustment height channel mounts.

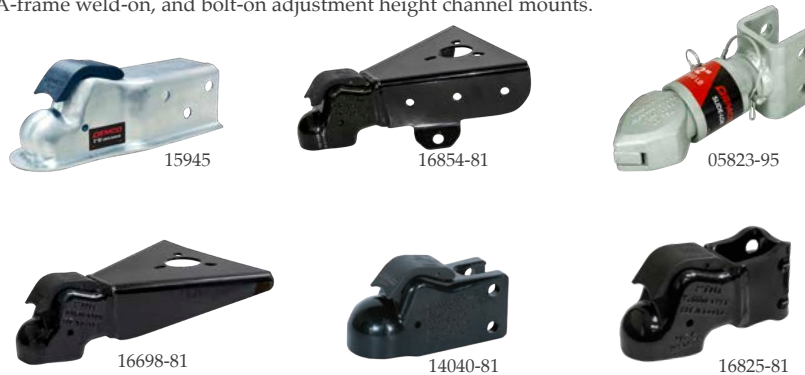

PART DESCRIPTION	PART #
2 5/16" EZ Latch G.V.W.R.	15945
2" EZ Latch A-frame with chain anchor 10,000 lb. G.V.W.R.	16854-81
2" Slide-Lok 7,000 lb. G.V.W.R.	05823-95
2" EZ Latch A-frame 10,000 lb. G.V.W.R.	16698-81
2 5/16" EZ Latch 21,000 lb. G.V.W.R.	14040-81
2" EZ Latch 10,000 lb. G.V.W.R.	16825-81

For a complete list of parts or more information, please visit our website



Faster, Easier Sway Control

e2 trunnion

Built-in sway control and weight distribution make towing faster, easier, and safer for you and your family.

Permanent sway control for when you're on downhill grades, towing heavy loads, passing semi-trucks, fighting crosswinds, and making quick maneuvers.

The perfect hitch for RV, boat, cargo, construction, and ATV trailers.

No chains or add-ons to remove when backing up, or driving in inclement weather.

Weight distribution keeps your truck, trailer, and cargo safer, due to improved steering control and stopping power.

Available in 4,500 lb, 6,000 lb, 8,000 lb, 10,000 lb, and 12,000 lb weight ratings.

Brackets are mounted 27" – 30" back from the center of the hitch ball.

e2 round bar

Built-in sway control and weight distribution make towing faster, easier, and safer for you and your family.

Permanent sway control for when you're on downhill grades, towing heavy loads, passing semi-trucks, fighting crosswinds, and making quick maneuvers.

The perfect hitch for RV, boat, cargo, construction, and ATV trailers.

No chains or add-ons to remove when backing up, or driving in inclement weather.

Weight distribution keeps your truck, trailer, and cargo safer, due to improved steering control and stopping power.

Available in 6,000 lb, 8,000 lb, and 10,000 lb weight ratings.

Brackets are mounted 24" – 27" back from the center of the hitch ball.

e2 HITCH



Part #	Max tongue wt./Max trailer wt.
92-00-0450	450/4,500 lb
92-00-0600	600/6,000 lb
92-00-0800	800/8,000 lb
92-00-1000	1,000/10,000 lb
92-00-1200	1,200/12,000 lb
92-00-1033	1,000/10,000 lb (no shank model)
92-00-1065	1,000/10,000 lb (hitch ball installed)



Part #	Max tongue wt./Max trailer wt.
94-00-0600	600/6,000 lb
94-00-0800	800/8,000 lb
94-00-1000	1,000/10,000 lb
94-00-1033	1,000/10,000 lb (no shank model)
94-00-1061	1,000/10,000 lb (hitch ball installed)



e2 Shanks

Part #	Trunnion	Round Bar
92-02-4100	0.5" drop/6" rise x 12" length	2.5" drop/5.5" rise x 12" length
92-02-4213	2" drop/8" rise x 12" length	4" drop/7.5" rise x 12" length
92-02-4214	4" drop/9.5" rise x 12" length	6" drop/9" rise x 12" length
92-02-4315	6.5" drop/12.5" rise x 12" length	8.5" drop/12" rise x 12" length



Fastway e2 - Faster, Easier.™





SCALE

INTEGRATED SCALE BALL MOUNT
INTEGRATED SCALE HD BALL MOUNT

Measures trailer tongue weight
Integrates mechanical spring scale
Gives you confidence and peace of mind
Helps balance trailer load for improved towing safety
Enjoy better steering, braking, and reduced trailer sway



Steel

SOLID STEEL BALL MOUNT
SOLID STEEL HD BALL MOUNT

Massive tow ratings, up to 20k for HD models
Commercial-grade towing capacity and strength
Solid shank made from forged steel
Ultimate towing confidence



Simple

E SERIES™ BALL MOUNT
E SERIES HD™ BALL MOUNT

Light weight corrosion-resistant aluminum
Adjustments made quick and easy
Super strength alloy
18k towing capacity for HD models



Silent

SILENT TOW BALL MOUNT

Virtually eliminates hitch rattle for a quiet tow
Fast and easy adjustments save time and effort
Corrosion-resistant aluminum
Years of excellent performance



Secure

ADJUSTABLE LOCKING BALL MOUNT
ADJUSTABLE LOCKING HD BALL MOUNT

Integrated locking pins for ultimate security
Fast and easy adjustments save time and effort
Convenient front-facing locks
Excellent choice for towing multiple trailers



Part #	Drop	Rise	Shank
48-00-8400	4"	5"	2"
48-00-8600	6"	7"	2"
48-00-8800	8"	9"	2"
48-00-8900	10"	11"	2"
48-00-8625*	6"	7"	2½"
48-00-8825*	8"	9"	2½"
48-00-8925*	10"	11"	2½"

Part #	Drop	Rise	Shank
49-00-5600	6"	6"	2"
49-00-5900	10"	10"	2"
49-00-5625*	6"	5"	2½"
49-00-5925*	10"	9"	2½"

Part #	Drop	Rise	Shank
42-00-2400	4"	5"	2"
42-00-2600	6"	7"	2"
42-00-2800	8"	9"	2"
42-00-2900	10"	11"	2"
42-00-2625*	6"	7"	2½"
42-00-2825*	8"	9"	2½"
42-00-2925*	10"	11"	2½"

Part #	Drop	Rise	Shank
47-00-3400	4"	5"	2"
47-00-3600	6"	7"	2"
47-00-3800	8"	9"	2"
47-00-3900	10"	11"	2"
47-00-3606	6"	7"	2½"
47-00-3806	8"	9"	2½"
47-00-3906	10"	11"	2½"

Part #	Drop	Rise	Shank
44-00-4400	4"	5"	2"
44-00-4600	6"	7"	2"
44-00-4800	8"	9"	2"
44-00-4900	10"	11"	2"
44-00-4606	6"	7"	2½"
44-00-4806	8"	9"	2½"
44-00-4906	10"	11"	2½"
44-00-4625*	6"	7"	2½"
44-00-4825*	8"	9"	2½"
44-00-4925*	10"	11"	2½"

* HD version





Fastway Trailer Products - Faster, Easier.™



ZIP™ Breakaway Cable

The coiled cable stays safely off the ground while you're towing, preventing wear and tear to the cable, and providing years of lasting use.

Part #	Description
80-00-2040	4' Cable and Switch
80-00-2060	6' Cable and Switch
80-01-2204	4' Cable and Pin
80-01-2206	6' Cable and Pin
80-01-2140	4' Universal Cable
80-01-2160	6' Universal Cable



FLIP™ Automatic Jack Foot

Extends your trailer jack by six inches, eliminating 48 cranks in one direction, saving you time and effort. No more searching for wood blocks or rocks to put under the trailer jack.

Part #	Description
88-00-4500	FLIP 4" Jack Foot
88-00-6500	FLIP 6" Jack Foot



ONESTEP™ Stabilizing Wheel Chock

Locks both wheels in place, allowing you to freely move around your trailer, with virtually no wheel movement. Can be set or removed from a standing position.

Part #	Description
84-00-4000	ONESTEP Wheel Chock
84-00-4150	ONESTEP XL Wheel Chock
84-00-4840	ONESTEP Double Pack



SHIN GUARD

Protects your shins by providing a cushion between your shin and the hard edges of the ball mount.

Part #	Description
82-00-3125	Black SHIN GUARD
82-00-3126	Orange SHIN GUARD
82-00-3127	Yellow SHIN GUARD



FORTRESS™ Coupler Lock

Toughest coupler lock available, fits virtually every coupler style, is corrosion resistant and provides superior security.

Part #	Description
86-00-5015	FORTRESS Coupler Lock



BALL COVER

Saves time cleaning off road grime and re-greasing the hitch ball.

Part #	Description
82-00-3220	2" BALL COVER
82-00-3216	2-5/16" BALL COVER



7-PIN PLUG COVER

Keeps dirt and debris out of your wiring harness.

Part #	Description
82-00-3315	7-PIN PLUG COVER



CHAIN UP™

The most secure way to keep your safety chains off the ground and working properly.

Part #	Description
82-00-3065	CHAIN UP for Ball Mount
82-00-3090	CHAIN UP for Weight Distribution & Multi Ball



RECEIVER LOCK

Securely locks your hitch into your receiver.

Part #	Description
86-00-3050	Locking Hitch Pin - For 2" Receivers
86-00-3160	Locking Hitch Pin - For 2-1/2" Receivers

Fastway - Faster, Easier.™



TOWING

TOWING

THE ORIGINAL
Equal-i-zer
SWAY CONTROL HITCH | **75**
YEARS OF
SAFETY



The Original Equal-i-zer® Sway Control Hitch has kept families safe on the road, providing peace of mind for more than 75 years.

Manufactured in the USA from 100% American-made steel, it is the only hitch with Integrated 4-Point Sway Control®, an advanced system that integrates sway control and weight distribution into one unit. The result is superior sway control performance, excellent weight distribution, exceptional quality, and ease of use.

The Equal-i-zer hitch has received the Trailer Life Magazine Readers' Choice Gold Award nine years in a row by trailer owners across America, and is the only hitch to have received the gold award. Towing with America's Favorite Hitch™ gives you confidence, peace of mind, and the best protection for your journey.

PARTS AND PRICING

STANDARD MODELS with standard shank (ball not included)

MFG Part #	Description
90-00-0400	400/4,000 lb
90-00-0600	600/6,000 lb
90-00-1000	1,000/10,000 lb
90-00-1200	1,200/12,000 lb
90-00-1400	1,400/14,000 lb
90-00-1600	1,600/16,000 lb

NO-SHANK MODELS for use with adjustable shanks

MFG Part #	Description
90-00-0401	400/4,000 lb
90-00-0601	600/6,000 lb
90-00-1001	1,000/10,000 lb
90-00-1201	1,200/12,000 lb
90-00-1401	1,400/14,000 lb

STANDARD MODEL with 2 5/16" ball

MFG Part #	Description
90-00-1069	1,000/10,000 lb

EQUAL-I-ZER® HITCH BALLS

MFG Part #	Description
91-00-6080	2" 8,000 lb
91-00-6100	2-5/16" 10,000 lb
91-00-6120	2-5/16" 12,000 lb
91-00-6140	2-5/16" 14,000 lb
91-00-6160	2-5/16" 16,000 lb
70-00-4800	1-7/8" Thin Walled Socket

2" ADJUSTABLE SHANKS

MFG Part #	Description
90-02-4100	3" Drop/7" Rise x 12" Length
90-02-4200	4" Drop/8" Rise x 12" Length
90-02-4300	6" Drop/10" Rise x 12" Length
90-02-4400	9" Drop/13" Rise x 12" Length
90-02-4711	12" Drop/15" Rise x 12" Length
90-02-4500	3" Drop/7" Rise x 18" Length
90-02-4600	4" Drop/8" Rise x 18" Length

2" ADJUSTABLE 4K SHANKS only for use with 4K hitch

MFG Part #	Description
90-02-4140	4K: 3" Drop/7" Rise x 12" Length
90-02-4240	4K: 4" Drop/8" Rise x 12" Length
90-02-4340	4K: 6" Drop/10" Rise x 12" Length

2 1/2" ADJUSTABLE SHANKS

MFG Part #	Description
90-02-4125	3" Drop/7" Rise x 12" Length
90-02-4225	4" Drop/8" Rise x 12" Length
90-02-4325	6" Drop/10" Rise x 12" Length
90-02-4425	9" Drop/13" Rise x 12" Length
90-02-4725	12" Drop/15" Rise x 12" Length

Go to equalizerhitch.com/find-your-shank-size to help determine which shank you need.

THE BEST PROTECTION FOR YOUR JOURNEY.™





WEIGHT DISTRIBUTION HITCH BARS

The ultimate hitch in detail and design

Sold separately from the weight distributing hitch kits, hitch bars offer a full range of style and adjust-ability.

FEATURES

- Long hitch bars provide the extra length for bumper clearance
- Hitch bars can be used with round bar, trunnion bar or high-performance weight distributing systems
- Angled, extended, "T" and deep drop designs available
- Designed for use in the rise or drop position
- Refer to the diagrams to assist in determining the correct Length, Rise and Drop required for your Weight Distributing Hitch
- Limited lifetime warranty

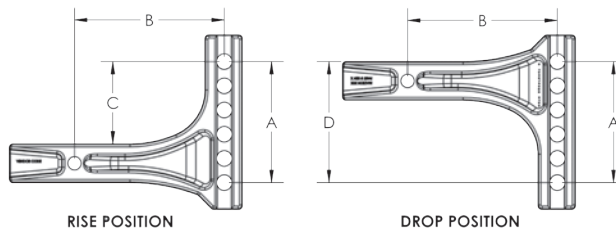

A: Height B: Length C: Rise D: Drop

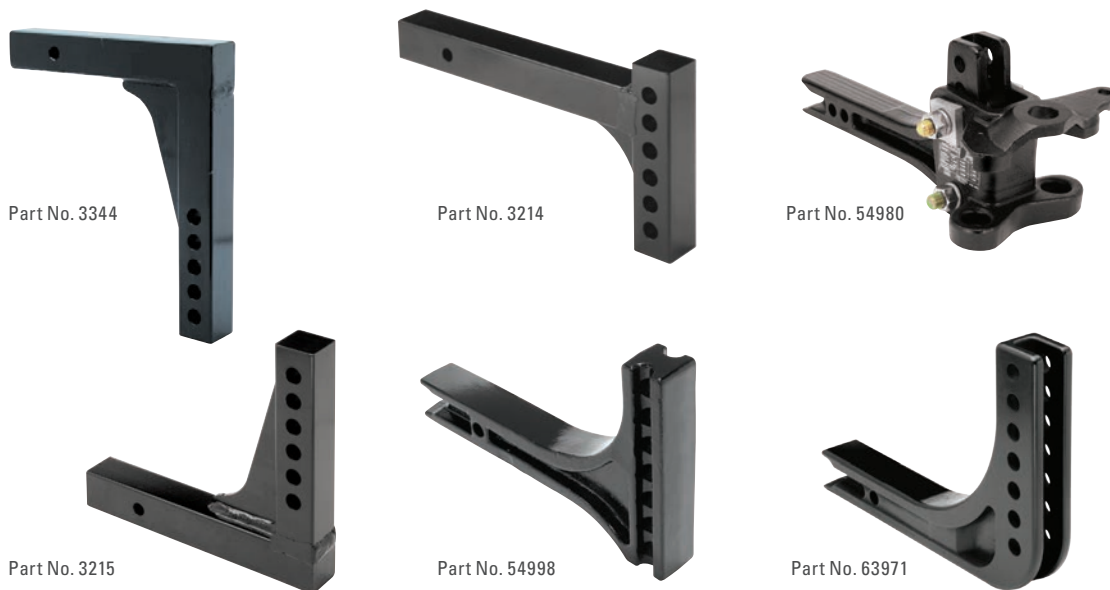

Weight Distribution Hitch Bars						
Part Number	Hitch Bar Size (in.)	Max Tongue Weight (lbs.)	A - Height (in.)	B - Length (in.)	C - Rise (in.)	D - Drop (in.)
63911	2	1,200	6-1/4	7-3/4	4-1/4	6-1/4
54970	2	1,500 1,000	6-1/4 6-1/4	9-1/4 10-1/4	4-1/4 4-1/4	6-1/4 6-1/4
3214	2	1,400	6-1/4	11-3/4	4-1/4	6-1/4
3215	2	1,400	6-1/4	8-3/4	8-3/4	10-3/4
3344	2	1,400	5	8-3/4	-	13-1/4
63971	2	1,500	7-1/2	9-3/4	-	10
54998	2	1,600	7-1/2	9-1/4	4-7/8	6-7/8
54980	Adjustable Trunnion Weight Distribution Bolt-Together Head Kit with Hitch Bar (54970)					
58167	Trunnion Weight Distribution Bolt-Together Head Kit					
58112	Adjustable Ball Mount with Hardware for Heavy Duty Round Bar					





PROPORTIONAL BRAKE CONTROLS

Innovative trailer braking solutions

For over 25 years, Tekonsha has been delivering the most reliable and trusted Proportional Trailer Brake Controls on the market. Proportional Technology that senses the type of braking even and applies appropriate power to the trailer brakes.

FEATURES

Digital LCD display with complete diagnostics readout

Why spend time looking for instructions to determine what the flashing means? The digital display allows for real time, comprehensive diagnostics.

OEM brake controls rely on a dashboard display or trailer brake control display for their own warning indicators or changes in trailer braking. Why wouldn't you?

Proportional braking

Fully tested for a smooth highway, in-city or off-road experience. No need to switch to a manual mode!

Manual override

Unlike a push knob for manual override, Tekonsha incorporates a variable override. This feature manually gives your brakes a little or a lot of stopping power depending on your needs.

"Boost" feature

Provides your trailer brakes with more initial power.

"Plug & Play" feature

Provides you with quick and easy connections.

Ease of installation and removal

By simply mounting the pocket mount bracket to your dash, you can easily remove your brake control for storage or use in another vehicle. Includes mounting bracket, hardware and pigtail harness kit.

Storable settings

Allows you to store up to 5 different settings giving personalized preferences at the push of a button for multiple users and/or multiple trailers (available on Prodigy P3).

Limited lifetime warranty

On all digital, proportional brake controls.



90195



90885



90160



9030



8508220

TRAILER MOUNTED BRAKE CONTROL

Their ease of operation and innovative design features make them the perfect choices for you towing needs

No matter what you are towing, Tekonsha® will help you stop it.

FEATURES

- User does not need a dash mounted, hard wired brake control
- For use on any trailer with up to 3 braking axles, no leveling required
- True proportional trailer braking, forward or reverse
- Trailer braking power supplied via 7-Way connector from the vehicle
- Multiple mounting options on the tongue or front of the trailer
- Includes remote hand held unit that plugs into any standard 12 volt power accessory adapter

TIMED BRAKE CONTROLS

FEATURES

- Small compact design
- Easy push button adjustment for output and sync
- Plug and play feature allows quick and easy connection
- Digital Display output setting, sync setting, brake overload or short connection
- Advanced internal circuit protection
- No leveling required and mounts in any direction
- For use on 12 volt negative ground systems only



902502



8507120



PRO™ SERIES

FEATURES

- Large easy to read dual digital display
- Protection against short circuit/loss of ground
- Microprocessor allows control to be mounted upside down and still have a readable display
- Standard mounting bracket included with optional ball mount available
- For use on any 12 volt negative ground system
- Plug & Play feature allows quick and easy connection
- Limited lifetime warranty

FEATURES

- Solid state electronics
- Power-on LED for a positive tow vehicle-to-trailer connection
- "Up- front" manual over-ride control
- Rugged, easy mount chassis
- Smooth and simple installation, mounting hardware included
- Plug & Play feature allows quick and easy connection
- 5 year limited warranty



80550



80500

This TEKONSHA® universal brake control harness with diode protection is designed to protect the vehicles wiring system from electrical back feed through the stop light signal. This harness will mate with any TEKONSHA®, Draw-Tite®, or REESE® brake controller. Simply wire in the harness and then plug into the controller to complete installation. This harness makes it easy to move the brake controller from one vehicle to another by just unplugging.



20160



7865



7894

TOWING

TOWING

If you're not sure you're within the law, have the Outlaw on your side*



SUPERHITCH ORIGINAL 20K



Tongue Weight* | Pull*
2,000 lbs | 20,000 lbs

SUPERHITCH MAGNUM 30K



Tongue Weight* | Pull*
3,000 lbs | 30,000 lbs

SUPERTRUSS EXTENSION



Highest capacity in the industry (12k lbs @ 48")

Eight lengths from 21" to 60"

SuperHitch sold separately

SkidWheel sold separately

- Designed for campers with up to 12 foot overhang to allow for towing
- Unbeatable twin beam extension system
- Hardened reinforced hitch pin locations
- Uses patented, lateral-support safety chains

Best Selling

36" Extension
Tongue Weight*
1,200 lbs

Pull*
12,000 lbs

Best Selling

48" Extension
Tongue Weight*
1,200 lbs

Pull*
12,000 lbs

*Max tongue weight/pull achieved with weight distribution

SUPERTRUSS EXTENSION



Extend your towing capabilities with SuperTruss*

*Torklift recommends towing within the capacities set by your vehicle manufacturer.

TORKLIFT
INTERNATIONAL





See roadmasterinc.com/patent for patent information



Time Tested • Time Proven



World's first illuminated tow bar

The Nighthawk is a non-binding, aluminum alloy tow bar incorporating a jaw-dropping design with embedded LED lights. It includes internally-routed safety cables and power cord, an attractive black matte finish and solid stainless steel inner arms.

Nighthawk is Roadmaster's first tow bar designed for 'direct-connect' baseplates, which incorporate the strength of the crossbar into the baseplate. So, no crossbar is required.

Aesthetically, the Nighthawk emulates the clean, sleek look of the Sterling All-Terrain tow bar, with which it shares many performance and convenience features, including a military-grade aluminum alloy shell.

- Non-binding Freedom Latch™ — disconnects first time, every time
- The Nighthawk has the longest tow bar arms ever produced, for maximum stability while towing.
- Solid stainless steel inner arms for smooth, trouble-free operation and easy maintenance
- Built-in channel guides — support and protect the included safety cables and power cord



A row of 300-lumen LEDs along each tow bar arm illuminates with the motorhome's lights, adding safety and convenience to nighttime towing.

676
Nighthawk tow bar
 8,000-lb weight capacity aluminum motorhome-mounted tow bar — weighs 35-lbs (Includes safety cables and power cord)

677
Nighthawk for Blue Ox baseplates

TOW BAR ADAPTERS



Shown: 030 adapts Blue Ox tow bars to Roadmaster baseplates

030
 Adapts Blue Ox motorhome mounted tow bars to direct-connect baseplates

031
 Adapts the following tow bars to Blue Ox baseplates: Falcon; Falcon All-Terrain; BlackHawk 2 All-Terrain (serial # up to 16,500); Sterling (serial # up to 14,500).

031-5
 Adapts all Sterling tow bars (serial # above 14,500), BlackHawk 2 All-Terrain tow bars (with serial # above 16,500) and Nighthawk tow bars to Blue Ox baseplates.

034
 Adapts the following tow bars to Demco baseplates: Falcon 2; Falcon All-Terrain; BlackHawk 2 All-Terrain (serial # up to 16,500); Sterling (serial # up to 14,500).

034-5
 Adapts all Sterling tow bars (serial # above 14,500), BlackHawk All-Terrain tow bars (serial # above 16,500) and Nighthawk tow bars to Demco baseplates (includes collar).





See roadmasterinc.com/patent for patent information

Time Tested • Time Proven

ALL-TERRAIN™

Non-binding tow bars



Made in the U.S.A.

Featuring the patented Freedom Latch, storage latch and built-in channel guides

Freedom Latch™ non-binding technology

No more binding!
(or skinned knuckles, or “#%?#^@?#!”)

A patented cam design inside the Freedom Latch transforms linear motion into rotary motion at a 400-to-1 ratio — five pounds of force against the latch equals 2,000 pounds of force against the lock. You’ll never have to straighten and align your towed vehicle to release the tow bar — Freedom Latches release at any angle. First time, every time. After all, who’s on vacation here — you, or your tow bar?

Exclusive features

- **Patented one-step storage latch**
Fold the tow bar toward the motorhome and it will “click,” automatically locking in place.
- **Built-in channel guides**
The safety cables and the power cord can be routed through the built-in channel guides for protection against damage or dragging, and for a clean, uncluttered look.
- **Solid stainless steel inner arms**
For smooth, trouble-free operation and easy maintenance. Stainless steel looks better, lasts longer and prevents corrosion that binds.
- **Largest hook-up radius**
No wasted time lining up your towed vehicle! You can’t say this about many things in life but connecting Roadmaster tow bars is just like horseshoes — “close” is good enough.
- **Metal-flake powder-coat finish**
Exceeds all 500-hour salt spray, extreme weather and high-impact standards.

Falcon All-Terrain

522 Falcon All-Terrain tow bar
6,000-lb. weight capacity motorhome-mounted tow bar — weighs 38 lbs.

527 Falcon All-Terrain tow bar for Blue Ox baseplates

Sterling™ All-Terrain

576 Sterling All-Terrain tow bar
8,000-lb. weight capacity aluminum motorhome-mounted tow bar — weighs 35 lbs. (Includes safety cables & power cord)

586 Sterling All-Terrain tow bar for Blue Ox baseplates

BlackHawk™ 2 All-Terrain

422 BlackHawk 2 All-Terrain tow bar
10,000-lb. weight capacity motorhome-mounted tow bar — weighs 42 lbs.

427 BlackHawk 2 All-Terrain for Blue Ox baseplates

World’s strongest aluminum tow bar!

The Sterling All-Terrain weighs just 35 pounds, yet pulls up to four tons. Comes with safety cables, the power cord and a powder-coat finish. (Specifications subject to change).



See roadmasterinc.com/patent for patent information





Time Tested • Time Proven



Stow and go

In the folded position, the Falcon 2 conveniently stores out of the way on the back of your motorhome. A tow bar cover (sold separately) keeps your tow bar clean.

See roadmasterinc.com/patent for patent information

6,000-lb. weight capacity motorhome-mounted tow bar

- Stainless steel in virtually every moving component for smooth, trouble-free operation.
- Autowlok™ locking mechanism — allows both tow bar arms to extend or retract for a quick connection. Drive away and the arms self-center and automatically lock.
- A patented latching mechanism ensures secure, easy storage on the back of your motorhome.
- Easily connect/disconnect the Falcon 2 in seconds.
- Full-length, steel crossbar for maximum support
- A lustrous powder-coat finish for maximum durability

520 Falcon 2 tow bar. weighs 37 lbs.

525 Falcon 2 tow bar fits Blue Ox baseplates

066 Falcon 2 & StowMaster Release Tool The release tool aids in unlocking tow bar arms when bound — not necessary with any All-Terrain tow bar or the Nighthawk

TRACKER™

The safest, strongest, easiest, most durable, trouble-free, 5,000-lb. rated, A-frame tow bar manufactured...

BAR NONE!

020 Tracker tow bar
Weight 20 lbs.; fits standard 2" ball
Note: Optional set of quick-disconnects (part number 201) is necessary to remove the front extensions.
Note: Will not fit 'direct-connect' style baseplates.



STOWMASTER™
America's Best-Selling Car-Mounted Tow Bar

6,000-lb. weight capacity car-mounted tow bar

- Stainless steel in virtually every moving component for smooth, trouble-free operation.
- Autowlok locking mechanism — allows both tow bar arms to extend or retract for a quick connection. Then, as you drive away, the arms self-center and automatically lock.
- Self-lubricating nylon bushings eliminate friction between the arms. Other manufacturers use steel on steel.
- Plug-welded arms — steel plugs seal both ends of the tow bar, preventing corrosion from moisture and debris.
- Full-length, steel crossbar for maximum support
- A lustrous powder-coat finish for maximum durability

501 StowMaster tow bar weighs 48 lbs

504 StowMaster tow bar with 2-5/16" coupler (special order)

581 StowMaster tow bar with 2 1/2" pintle ring.

583 StowMaster tow bar with 3" pintle ring (special order)





Time Tested • Time Proven

TOWED VEHICLE SUPPLEMENTAL BRAKING



'Set-it-and-forget-it'
braking system

A revolutionary innovation in supplemental braking — nothing.

Zip. Zero. Zilch. Nothing. Nada. Nil. That's what you have to do to connect and disconnect InvisiBrake. There's nothing to take in or out of your towed vehicle and there's nothing to push, pull, set, adjust, activate or deactivate. What could be easier than nothing at all?



WHAT IS INVISIBRAKE®?

InvisiBrake is a fully-automatic supplemental braking system that uses the electrical connections already in place on your towed vehicle (the towed vehicle's electrical harness) to brake when you brake the motorhome — the same electrical signal that activates the towed vehicle's brake lights also activates InvisiBrake.

• OUT OF SIGHT

InvisiBrake is so small (8¾" x 8¾" x 2¾") it can usually be mounted under the driver's seat, under the rear seat, behind interior panels or in the trunk, without sacrificing any of the vehicle's usable space.

• SET-IT-AND-FORGET-IT BRAKING

Once it's installed, InvisiBrake just works. Nothing for you to remember — not even an 'on' switch — just plug in the umbilical cord like you always do and you're ready to go!

• CHARGES YOUR BATTERY WHILE TOWING

InvisiBrake trickle-charges your battery during towing — InvisiBrake will never drain it.

• TWO-STAGE MOTORHOME MONITOR

Includes an LED monitor for a visual reference of braking activity; an alert at the motorhome will warn you if the brakes have been on for too long.

• ACTIVATES ONLY WHEN THE MOTORHOME'S BRAKE LIGHTS ILLUMINATE — no false braking!

• ENERGIZES YOUR POWER BRAKES — InvisiBrake energizes power brakes instead of working on a 'dead' pedal.

• WORKS IN VIRTUALLY ANY TOWED VEHICLE WITH VACUUM-POWERED BRAKES

Including hybrids and those with full-time ('active') power braking systems.

• INCLUDES EMERGENCY BREAK AWAY SYSTEM

• EASILY ADJUSTS TO INDIVIDUAL PREFERENCES

Braking pressure is adjustable from 5 to 100 psi.

• MEETS U.S. AND CANADIAN BRAKING REQUIREMENTS

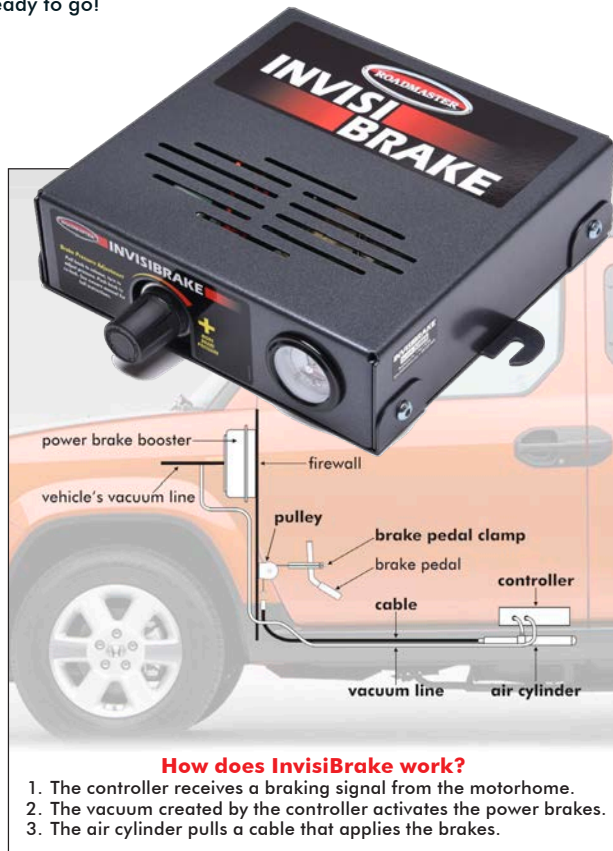

How does InvisiBrake work?

1. The controller receives a braking signal from the motorhome.
2. The vacuum created by the controller activates the power brakes.
3. The air cylinder pulls a cable that applies the brakes.

8700 InvisiBrake





Time Tested • Time Proven

COMBO KITS

Tow bars, you've met your match.

Combo Kits contain the accessories you need, matched to your Roadmaster tow bar.

Each Combo Kit contains:

- A wiring kit with four 'Hy-Power' diodes and two bulbs and sockets for flexibility
- A power cord to connect the vehicles, with a 7-wire plug for the motorhome (attached) and a plug and socket for the towed vehicle (Note: The Sterling All-Terrain and Nighthawk tow bars come with power cords, so their Combo Kit does not include one)
- A bracket to mount the power cord socket
- A pair of safety cables, rated at 6,000-, 8,000- or 10,000-lb. capacity (Note: The Sterling All-Terrain and Nighthawk tow bars come with safety cables, so their Combo Kit does not include them)
- Two or three case-hardened steel padlocks (keyed alike) — for added security
- A marine-grade vinyl cover to protect your tow bar
- A marine-grade vinyl storage bag — for all your towing accessories

INCLUDES BULBS AND SOCKETS!



shown: 9243-1

- 9284-2 Sterling All-Terrain and Nighthawk Combo Kit**
Does not include safety cables or power cord; includes receiver hitch lock and silicone spray
- 9243-1 Falcon 2 and Falcon All-Terrain Combo Kit**
6,000-lb. capacity — with hybrid (coiled-to-straight) safety cables and hybrid (coiled-to-straight) power cord
- 9243-3 BlackHawk 2 All-Terrain Combo Kit**
10,000-lb. capacity — with straight safety cables and straight power cord
- 9252 StowMaster Combo Kit**
6,000-lb. capacity — with coiled safety cables and coiled power cord

TOW BAR PADLOCKS

COUPLER PADLOCK



QUICK-DISCONNECT PADLOCK



RECEIVER HITCH LOCK



Don't spend your time worrying about a stranger or kids unlatching or removing your safety pins. Replace them with padlocks and peace of mind. Padlocks discourage theft and tampering and protect against accidental release. Hardened steel shackle, double ball locking mechanism, and solid brass tumblers and components.

- 302 2-pack quick-disconnect padlocks (keyed alike)**
- 303 2-pack quick-disconnect padlocks and 1 coupler padlock (keyed alike)**
- 308 4-pack quick-disconnect padlocks (keyed alike)**
- 304 1 receiver hitch lock and 2-pack quick-disconnect locks**
- 305 Coupler padlock**
- 315 Receiver hitch lock**
- 316 2-pack receiver hitch locks (keyed alike)**



TOWING

TOWING



Center Hub Requires Minimum 1" Clearance

PROTECT WHAT YOU TOW!® FROM ROCKS, MUD, DEBRIS & ROAD TAR

EASY ON AND OFF!

Use it when you're towing, take it off when you're not-



PART# 00108

Rock Tamers® 2" Hub Mudflap System Matte Black w/Stainless Steel Trim Plates

FITS **2"**

DRAWBAR/RECEIVER

PART# 00110

Rock Tamers® 2.5" Hub Mudflap System Matte Black w/Stainless Steel Trim Plates

FITS **2½"**

DRAWBAR/RECEIVER

PART# 00112

Rock Tamers® 3" Hub Mudflap System Matte Black w/Stainless Steel Trim Plates

FITS **3"**

DRAWBAR/RECEIVER

ADJUSTABLE WIDTH & HEIGHT TO FIT MOST VEHICLES

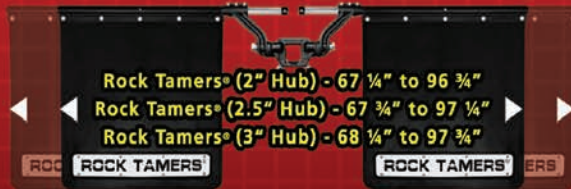

- ▶ UV PROTECTED FORGED ALUMINUM HUBS & ARMS
- ▶ 3/8" THICK; 24" X 24" WIDE FIBER REINFORCED RUBBER MUDFLAPS
- ▶ STAINLESS SLEEVED STEEL RODS, STAINLESS & ZINC NICKEL HARDWARE

PART # 00400 Stand Requires Standard 2" Ball Mount for Display (Not Included)

RT231 HEAT SHIELD*
Patent Pending



RT200 EXHAUST OUTLET*
Patent Pending



RT240 TAIL LIGHT BAR*
Patent Pending



*Rock Tamers® System Sold Separately

TIRE MINDER

TIRE PROTECTION PEACE OF MIND



TireMinder i10 RV TPMS

INCLUDES HI-POWERED BOOSTER AND FLOW THROUGH OR STANDARD SENSORS

Part #	MFG #	DESCRIPTION
	TM22141	i10 with 4 Standard Sensors
	TM22142	i10 with 6 Standard Sensors
	TM22143	i10 with 10 Standard Sensors
	TM22163	i10 with 4 Flow Through Sensors Sensors
	TM22164	i10 with 6 Flow Through Transmitters
	TM22115VP	Extra Standard Brass Sensors (2-Pack)
	TM22156VP	Extra Flow Through Sensors (2-Pack)
	TM22114VP	Extra Standard Aluminum Sensors (2-Pack)



TireMinder A1AS RV TPMS

INCLUDES HI-POWERED BOOSTER AND FLOW THROUGH OR STANDARD SENSORS

Part #	MFG #	DESCRIPTION
	TM22129	A1AS with 4 Standard Sensors
	TM22130	A1AS with 6 Standard Sensors
	TM22135	A1AS with 10 Standard Sensors
	TM22157	A1AS with 4 Flow Through Sensors Sensors
	TM22158	A1AS with 6 Flow Through Transmitters
	TM22115VP	Extra Standard Brass Sensors (2-Pack)
	TM22156VP	Extra Flow Through Sensors (2-Pack)
	TM22114VP	Extra Standard Aluminum Sensors (2-Pack)

www.TireMinder.com



PRODUCT INDEX

<p>A</p> <p>AP Products Doors & Hardware 36-37 LP Tank Sensor 49</p> <p>B</p> <p>B & W Ball Mounts 76-78 Fifth Wheel Hitches 71-73 Goosenecks 74-75</p> <p>Bargman Connectors 13 LED Lights 12</p> <p>C</p> <p>Camco Propane Tank Cover 50 Roof Vent Cover 47-49 Sewage Accessories 58</p> <p>Classic Accessories RV Covers 44-46 Tire Covers 46</p> <p>Curt Manufacturing Accessories (Towing) . . 87, 94, 103, 112-113 Ball Mounts 95-103, 110 Brake Controllers 79-81 Fifth Wheels 82-86 Hitch Locks 103-109, 111 Sway Controls 88 Weight Distribution 89-93</p> <p>D</p> <p>Demco Accessories (Towing) 115-124 Fifth Wheel Hitches 119-122 Mounting Bracket Kits 123 SMI Braking System 117 Weight Distribution 114</p> <p>Dicor Roof Cleaning & Protection . 26-27 Roofing Systems 30 Sealants 28-29, 31 Valve Extenders 67 Wheels 65-66</p>	<p>F</p> <p>Fastway Accessories 127 Ball Mounts 126</p> <p>Fastway (Equalizer) Sway Control 128</p> <p>Fastway (Equalizer E2) Weight Distribution 125</p> <p>Firestone Air Springs 60-62</p> <p>G</p> <p>Go Power Battery 7 Controllers 9 Portable Solar Kits 7-9</p> <p>J</p> <p>JR Products Cabinet Hardware 34-35 Curtain Hardware 35-36 Door Holders/Handles 33-34 Exterior Hardware 32 Gas Spring 36 Interior Hardware 32-33 Locks 32 Registers 33 Vinyl 34 Vinyl Inserts 33</p> <p>K</p> <p>Kwikkee Products Steps 42 Step Motors & Accessories . 42-43</p> <p>L</p> <p>Lippert Brake Kits 69 Jacks 59 Motors 68 Stabilizers 69 Steps 42</p>	<p>M</p> <p>Marshall Excelsior Gas Adapter Tees 51 Gas Hoses/ Pigtails 50-51 Regulators 50</p> <p>N</p> <p>Norcold Refrigerators 6</p> <p>O</p> <p>Optronics Connectors 12 LED Lighting 10-11</p> <p>P</p> <p>Phoenix Industries Faucets 52-54 Hoses 52</p> <p>Pollak Engineered Prod Connectors 12-13</p> <p>Prest-o-Fit Steps 38-40 Mats 38-39</p> <p>R</p> <p>RAM Jacks 59</p> <p>Reese Weight Distribution Hitch 129</p> <p>Remco Water Pumps 55</p> <p>Roadmaster, Inc. Accessories (Towing) 137 Brake Controllers 136 Tow Bars 104</p> <p>Rocktamers Mud Flap System 138</p>	<p>S</p> <p>Sika Sealants 25 Tapes 25</p> <p>Southwire Adapters 23-24 Portable Power 17 Surge Protectors 19-21 Tools 18, 22</p> <p>Starlights Inc. LED Lights 12</p> <p>T</p> <p>Tectran Connectors 12</p> <p>Tekonsha Adapters 13 Brake Controls 130-131 Connectors 13</p> <p>TireMinder TPMS 139</p> <p>Torklift Steps 41 Suspension 63 Tiedowns & Turnbuckles 64 Towing 132</p> <p>Trailer Tech Scissor Jack 59</p> <p>V</p> <p>Valterra Adapters 13-15 Extension Cords 15-16 Hoses 52 Regulators 52 Sewage Accessories 56-58 Vent Cover 49 Wheel Chocks 59</p> <p>Z</p> <p>Zarpax Dehumidifier 25</p>
--	--	---	--



PRODUCT INDEX

A

ABS Fittings [57](#)
Actuators [124](#)
Adapters
Electrical . [9, 13-15, 20, 23-24](#)
Hitch [87-98](#)
Water Hose [52](#)
Sewer Hose [56-58](#)
Tow Bar [133](#)

Adhesives (Roof) [25, 28-31](#)
Adjustable Ball Mount [78,](#)
..... [102-103, 126, 128-129](#)
Air / Helper Springs [60-62](#)
Aluminum Ball Mount . [99, 126](#)
Appliances / Refrigerator [6](#)
Assist Handle [34](#)
Automatic / Gas Regulator . [50](#)
Awning
Mats [40](#)

B

Ball
Hitch . [74-78, 90-100, 126-128](#)
Stud [36](#)
Sway Control . [89-94, 125, 128](#)
Ball Mount
Tri-Ball [108](#)
See Also: Adjustable
Base [36](#)
Plates [116, 133-135](#)
Rails [85-86](#)
Bathroom Faucets [53-54](#)
Batteries [7-9](#)
Bladex Valves [58](#)
Bluetooth [8-9, 19, 51, 80](#)
Brackets
Interior [32-36](#)
Gas Regulator [50](#)
5th Wheel [121, 123](#)
Brake
Accessories [69, 117](#)
Boxes [117, 136](#)
Controls [79-81, 130-131](#)
Bulb Light [10-12](#)
Bumpers [32-35](#)
Butyl Tape [31, 49](#)

C

Cabinet / Hinges [35](#)

C cont.

Cap / Tape [25](#)
Changeover Regulator [50](#)
Chocks [59, 127](#)
Cleaner
Rubber Roof [26](#)
Coatings / Roof [26-31](#)
Conductor [16](#)
Connector
Electrical [12-13, 43](#)
Propane [50-51](#)
Sewer Hose [57](#)
Cord
Adapters [13-15, 23](#)
Connectors [13](#)
Extension [15-16, 24](#)
Power [15-16, 23](#)
Couplers
Lock [107-111, 124](#)
Sewer Hose [56-57](#)
Universal Lock [127](#)
Couplings / ABS [56-57](#)
Covers
AC [47](#)
Camper [45-46](#)
Propane [50](#)
Regulator [50](#)
RV [44-46](#)
Seat [47](#)
Tire [43](#)
Vent [47-49](#)
Wheel [47, 66](#)
Crank Handle Leveling Jack [59](#)
Curtains [35-36](#)

D

Dehumidifier [25](#)
Dogbone Adapter [14-15](#)
Door
Door Handles [33-34](#)
Entrance [32-35](#)
Hardware [32-35](#)
Holder [33-34](#)
Drain
Hose [56](#)
Hose Support [56](#)
Drinking Water
Hoses [52](#)

E

Elastomeric Roof Coat [26](#)
Electric
Lock [37](#)
Step Repair Kits [42-43](#)
Steps [41-42](#)
Electrical
Adapters [13-15](#)
Connectors [12-13, 43](#)
Cords [13-16, 23-24](#)
Wiring [12-13, 87, 115](#)
[122, 137](#)
Electronic
Brake Controls [79-81, 130-131](#)
Entrance Door / Lock ... [32-33](#)
Equalizer W/D Hitches [125](#)
Generator Cords [14-15](#)
Extension Cord [15-16, 24](#)
EZ Couplers [56-57](#)

F

Faucets
Bathroom [53](#)
Kitchen [52-53](#)
Shower [53-54](#)
Single Lever [53](#)
Fifth Wheel
Base Rails [85-86](#)
Cover [47](#)
Hitches [71-73, 82-86](#)
[119-123](#)
Wiring Harness. ... [12-13, 87,](#)
[122, 131, 137](#)
Fill Hose [52](#)
FillFresh Water [52](#)
Fittings
ABS [57](#)
Sewer Hose [56-58](#)
Flex Guard [69](#)
Folding
Sewer Hose Support [56](#)
Step [41-42](#)
Tailgate & Towing [112-113, 118](#)
Fresh Water Fittings [52](#)
Friction Sway Control ... [89-90](#)

G

Gas
Hose [51](#)
Regulator [50](#)



PRODUCT INDEX

G cont.

- Gas
 - Spring [36](#)
 - Struts [36](#)
- Generators
 - Adapter [13-15, 23](#)
 - Cord [15-16](#)
- Gooseneck
 - Accessories [74-75, 112](#)
 - Coupler [74-75](#)
 - Hitch [74-75](#)
- Gutter Spout [32](#)

H

- Handle / Assist [34](#)
- Hardware
 - Cabinet Hardware [34-35](#)
 - Curtain Hardware [35-36](#)
 - Door Holders/Handles [33-34](#)
 - Exterior Hardware [32](#)
- Harness
 - Harness [12-13, 43, 68](#)
[122, 131](#)
 - Extensions [87](#)
- Heated Water Hose [52](#)
- Hi-Rise Kitchen Faucet [53](#)
- Hinges / Cabinet [34-36](#)
- Hitch
 - Ball Mounts [74-78, 90-100,](#)
[126-128](#)
 - Fifth Wheel [71-73, 82-86,](#)
[119-120](#)
 - Locks [109](#)
 - Weight Distributing [89-93,](#)
[125, 128-129](#)
- Holding Tank / Rinsers [58](#)
- Hose
 - Clamps [58](#)
 - Coupler Sewer [56-58](#)
 - Drain [53-56](#)
 - Drinking Water [51-52](#)
 - Hydraulic [67](#)
 - LP Gas [51](#)
 - Sewer [56-58](#)
 - Support [56](#)
- Hydroflush [57](#)

I

- Insert Vinyl Trim [33](#)

I cont.

- Interior
 - Hardware [32-36, 69](#)
 - Lighting [12](#)
- Inverter [7-9](#)

J

- Jacks
 - Handle [59](#)
 - Kit [59](#)
 - Scissor [59](#)
 - Tongue [59](#)

K

- Kitchen
 - Faucet [52-53](#)
 - Sink Accessories [52-53](#)
- Door Knob [34-35](#)

L

- Lap Sealant [26-30](#)
- Latch / Window [33, 37](#)
- Lavatory Faucets [53-54](#)
- LED
 - Bulb [10-12, 22](#)
- Legs Table [36](#)
- Leveling
 - Air [60-62](#)
 - Blocks [59](#)
 - Chocks [59](#)
 - Jacks [59](#)
 - Scissor Jacks [59](#)
- Light
 - Bulbs [10-12, 22](#)
 - LED [10-12, 22](#)
 - Solar [7-9](#)
- Locking / Ball Mount [126](#)
- Locks
 - Coupler [103-109, 127, 137](#)
 - Doors/Hatches [32-37](#)
 - Electronics [20](#)
- LP Gas
 - Bottle Covers [50](#)
 - Hoses [51](#)
 - Pigtails [50-51](#)
 - Regulators [50](#)

L cont.

- Sensors [51](#)
- ## M
- Marine [25](#)
 - Mat
 - Step [38-40](#)
 - Monitor
 - Battery [9](#)
 - Braking [136](#)
 - LP [51](#)
 - Voltage [20](#)
 - Motors [42, 68](#)
 - Motor / Scissor Jack [59](#)
 - Motorhome / Covers [44-46](#)
 - Mounts [35](#)
 - Mud Flaps [138](#)
 - Multi-tool [18, 22](#)
- ## O
- Outdoor
 - Mats [38-40](#)
 - Shower [54](#)
- ## P
- Passage Door Lock [32](#)
 - Padlock [108, 137](#)
 - Pigtail LP [50-51](#)
 - Pin / Safety [105](#)
 - Plug
 - Adapters [13-15, 20-24](#)
 - and-Play [80-81, 130-131](#)
 - Cover [13, 127](#)
 - Portable
 - Braking [117](#)
 - Power [9, 19-21](#)
 - Waste Tank [58](#)
 - Power
 - Adapters [13-15, 20-24](#)
 - Cords [13-16, 23-24](#)
 - Pressure Regulator
 - LP [51](#)
 - Water [52](#)
 - Propane
 - Pigtails [50-51](#)
 - Regulator [50-51](#)
 - Protectant [27](#)
 - Putty Tape [49](#)



PRODUCT INDEX

R

Refrigerator
Norcold [6](#)
Vents [49](#)
Registers [37](#)
Regulator
Accessories [50-51](#)
LP [50-51](#)
Water [52](#)
Rivet [37](#)
Roof
Cleaner [26-27](#)
Coating [26-27](#)
Repair Kit [28](#)
Sealant [25-31](#)
Roof Vents
Cover [47-49](#)
Rubber
Roof Cleaner [26-27](#)
Roof Coating [26-27](#)
Roof Repair [28](#)
Roofing [26-28](#)
RV "Y" Adapter [14, 24](#)

S

Sanitation Valves [57-58](#)
Scissor Jacks [59](#)
Sealant
Lap [28-31](#)
Putty Tape [29, 49](#)
Silicon [25](#)
Sewer
Coupler [57](#)
Fittings [57](#)
Hose Adapter [57](#)
Hose Support [56](#)
Hose System [56](#)
Shower / Faucet [53-54](#)
Slide Out
Lube [43](#)
Rubber Treatment [31](#)
Seal [30](#)
Slide Out Parts [68-69](#)
Sliding Door Hardware [33](#)
Slunky Hose Support [56](#)
Solenoid
Valve Accessories [68](#)
Stabilizers
Accessories & Parts [68-69](#)
Jack [59](#)
Scissor Jack [59](#)

S cont.

Step
Electric [42](#)
Folding [41](#)
Mats [39-40](#)
Repair Kit Electric [42-43](#)
Surge Protectors [19-23](#)
Suspension Stabilizer [60, 63](#)
Sway Control Parts &
Hardware [89-95, 125, 128](#)

T

Tank
Cover [50](#)
Portable Sewer [58](#)
Sensor [51](#)
Tape
Butyl [31, 49](#)
Cap [25](#)
Electrical [18, 22](#)
Putty [28](#)
Tie Downs/ Turnbuckles [64](#)
Tire
Covers [47](#)
Spare [118](#)
Tire Inflaters [67](#)
Toilet
Paper [58](#)
Tongue
Jacks [59](#)
Toy Hauler / Covers [45-46](#)
TPMS [139](#)
TPO Roof System [25, 27-31](#)
Trailer
Adapters [9, 13-15, 121](#)
Connector [12-13, 80](#)
Couplers [107-109, 124, 127](#)
Wiring Kit [12-13](#)
Trim Insert [33](#)
Triple Tow Ball Mount [76](#)
Tub & Shower
Accessories [36](#)
Faucet [53-54](#)

U

Universal Coupler Lock [109](#)

V

Vents
Ceiling [33](#)
Covers [48-49](#)
Floor [33](#)
Latch [32](#)
Refrigerator [49](#)
Roof [47](#)
Vinyl Insert Molding Trim [33](#)
Volt Regulator [18-20](#)
Voltage Monitor [20](#)

W

Waste Tank [58](#)
Waste Valves [57-58](#)
Water
Hoses [52](#)
Pressure Regulator [52](#)
Wax Trailer [26](#)
Weight Distributing
Hitches [89-93, 125, 128-129](#)
Wheel
Accessories [66](#)
Chocks [59, 127](#)
Covers [44-45, 47, 66](#)
Hub Covers [67](#)
Simulators [65](#)
Stops [59](#)
Window
Hardware [33-34, 37](#)
Sealing [29-30](#)
Wire Harness [12-13, 43, 87, 122, 127, 131](#)
Wires & Wiring [12-24](#)

*The Index may not be 100% correct. If using a digital copy of this catalogue, you can use "Ctrl+F" or "Cmd+F" to search the entire document for key words.



PRODUCT INDEX

PRODUCT INDEX

Wasilla, AK
2281 E. Sun Mnt. Ave.
Wasilla, AK 99654
(907) 376-8000
(800) 478-1902 (AK)

Fairbanks, AK
3060 S. Cushman
Fairbanks, AK 99701
(907) 452-6160
(800) 770-7499 (AK)

Anchorage, AK
4748 Old Seward Highway
Anchorage, AK 99503
(907) 344-7497

Anchorage, AK
3000 Commercial Dr.
Anchorage, AK 99501
(907) 276-5171
(800) 478-5173 (AK)

21 Locations to Serve You

www.sixrobblees.com
Fax: 844-384-9160

Seattle, WA
11010 Tukwila Intl. Blvd.
Tukwila, WA 98168
(206) 767-7970
(800) 275-7499

Everett, WA
3531 Paine Ave.
Everett, WA 98201
(425) 252-8666
(800) 963-8666 (WA)

Bellingham, WA
5236 Guide Meridian
Bellingham, WA 98226
(360) 398-7173
(866) 857-9194

Yakima, WA
E. 1206 Mead
Yakima, WA 98903
(509) 457-4123
(800) 275-2707 (WA)

Spokane, WA
N 909 Fancher
Spokane, WA 99212
(509) 535-8862
(800) 275-2709

Tacoma, WA
2020 Milwaukee Way E.
Tacoma, WA 98421
(253) 272-8413
(800) 980-9818 (WA)

Portland, OR
3677 SE Edison St.
Portland, OR 97222
(503) 652-9971
(800) 452-4754

Eugene, OR
275 N. Seneca
Eugene, OR 97402
(541) 485-8606
(800) 222-7874

Grants Pass, OR
109 SE Mill Street
Grants Pass, OR 97526
(541) 474-5568
(800) 961-4266

Rohnert Park, CA
5905 Labath Ave.
Rohnert Park, CA 94928
(707) 584-4484
(800) 275-2425

Oakland, CA
541 Julie Ann Way
Oakland, CA 94621
(510) 569-6323
(800) 275-2428

Great Falls, MT
815 Crescent Drive
Great Falls, MT 59404
(406) 761-6361
(800) 699-4335

Billings, MT
2437 Enterprise Ave.
Billings, MT 59102
(406) 248-1658
(800) 929-3578 (MT)

Casper, WY
4845 W. Yellowstone Hwy.
Casper, WY 82604
(307) 237-3071

Nampa, ID
16241 N Franklin Blvd
Nampa, ID 83687
(208) 461-1256

Twin Falls, ID
180 Deere Street
Twin Falls, ID 83301
(208) 733-6924
(800) 499-8350

Missoula, MT
7300 Hwy. 10 West
Missoula, MT 59808
(406) 721-0567
(800) 933-3097

